

## LSA 46.3

### Low Voltage Alternator - 4 pole

230 to 365 kVA - 50 Hz / 288 to 456 kVA - 60 Hz  
Electrical and mechanical data

LEROY-SOMER™

**Nidec**  
All for dreams

## The best of performance

Nidec Leroy-Somer LSA 46.3 alternator has been designed to offer you the best power generation performances. With its meticulous design and optimized architecture, the LSA 46.3 strikes the perfect balance between compactness, reliability, performance and longevity.

Whatever your application, the LSA 46.3 will meet your needs and will adapt to all situations.

## Standards

Nidec Leroy-Somer LSA 46.3 alternator meets all key international standards and regulations, including IEC 60034, NEMA MG 1.32-33, ISO 8528-3, CSA C22.2 n°100-14 and UL 1446 (UL 1004 on request). Also compliant with IEC 61000-6-2, IEC 61000-6-3, IEC 61000-6-4, VDE 0875G, VDE 0875N and EN 55011, group 1 class A for European zone.

Nidec Leroy-Somer LSA 46.3 alternator can be integrated in EC marked generator set, and bears EC, UKCA and CMIM markings. It is designed, manufactured and marketed in an ISO 9001 and ISO 14001 quality assurance environment.

## Electrical characteristics and performances

- Class H insulation
- 2/3 pitch winding, standard 12-wire (6) reconnectable
- Voltage range:
  - 50 Hz: 220V - 240V and 380V - 415V (440V)
  - 60 Hz: 208V - 240V and 380V - 480V
- High efficiency and motor starting capacity
- Other voltages are possible with optional adapted windings:
  - 50 Hz: 440V (no. 7), 500V (no. 9), 550V (no. 22), 600V (no. 23), 690V (no. 10 or 52)
  - 60 Hz: 380V and 416V (no. 8), 600V (no. 9), 690V (no. 22)

## Excitation and regulation system

Excitation system				Regulation options		
AVR	SHUNT	AREP (option)	PMG (option)	C.T. Current transformer for paralleling	Mains paralleling	Remote voltage potentiometer
R250	Standard					√
D350	Option	Standard	Standard	√*		√
D550	Option	Option	Option	√*	√	√

\*: only with AREP or PMG

3-phase sensing is included as a standard with digital regulators.

## Protection system and options

- The LSA 46.3 is IP 23
- Complete winding protection for clean environments with relative humidity ≤ 95 %, including indoor marine environments
- Options:
  - Filters on air inlet: derating 5%
  - Filters on air inlet and air outlet (IP 44): derating 10%
  - Reinforced winding protection for harsh environments and relative humidity greater than 95%
  - Space heater
  - Thermal protection for stator windings and shields

## Mechanical construction

- Compact and rigid assembly to better withstand generator vibrations
- Steel frame
- Cast iron flanges and shields
- Two-bearing and single-bearing versions designed to be suitable for engines on the market
- Half-key balancing
- Greased for life bearings, regreasable bearings (optional)
- Direction of rotation: clockwise and anti-clockwise (without derating)

## Terminal box design

- Easy access to the voltage regulator and to the connections
- Possible inclusion of accessories for paralleling, protection and measurement
- 9-way terminal block for voltage reconnection

# LSA 46.3 - 230 to 365 kVA - 50 Hz / 288 to 456 kVA - 60 Hz

## General characteristics

Insulation class	H	Excitation system	SHUNT	AREP / PMG
Winding pitch	2/3 (wind. 6)	AVR type	R250	D350
Number of wires	12	Voltage regulation (*)	± 0.5%	± 0.25%
Protection	IP 23	Short-circuit current	-	300% (3 IN) : 10s
Altitude	≤ 1000 m	Total Harmonic Distortion THD (**)	no load < 2.5% - on load < 2.5%	
Overspeed	2250 R.P.M.	Waveform: NEMA = TIF (**)	< 50	
Air flow	0.48 m³/s (50 Hz) / 0.58 m³/s (60 Hz)	Waveform: I.E.C. = THF (**)	< 2%	

(\*) Steady state (\*\*) Total harmonic distortion between phases, no-load or on-load (non-distorting)

## Ratings 50 Hz - 1500 R.P.M.

kVA / kW - P.F. = 0.8																				
Duty/T°C	Continuous duty/40°C					Continuous duty/40°C					Stand-by/40°C				Stand-by/27°C					
Class/T°C	H/125°K					F/105°K					H/150°K				H/163°K					
Phase	3 ph.			1 ph.		3 ph.			1 ph.		3 ph.		1 ph.		3 ph.			1 ph.		
<b>Y</b>	380V	<b>400V</b>	415V	440V	ΔΔ	380V	<b>400V</b>	415V	440V	ΔΔ	380V	<b>400V</b>	415V	440V	ΔΔ	380V	<b>400V</b>	415V	440V	ΔΔ
<b>Δ</b>	220V	<b>230V</b>	240V		230V	220V	<b>230V</b>	240V		230V	220V	<b>230V</b>	240V		230V	220V	<b>230V</b>	240V		230V
<b>YY</b>		<b>200V</b>		220V			<b>200V</b>		220V			<b>200V</b>		220V			<b>200V</b>		220V	
<b>LSA 46.3 S4</b> kVA	230	<b>230</b>	230	219	138	209	<b>209</b>	209	200	126	244	<b>244</b>	244	232	146	253	<b>253</b>	253	240	152
kW	184	<b>184</b>	184	175	110	167	<b>167</b>	167	160	101	195	<b>195</b>	195	186	117	202	<b>202</b>	202	192	122
<b>LSA 46.3 S5</b> kVA	240	<b>250</b>	250	238	150	218	<b>228</b>	228	216	137	254	<b>265</b>	265	252	159	264	<b>275</b>	275	261	165
kW	192	<b>200</b>	200	190	120	174	<b>182</b>	182	173	110	204	<b>212</b>	212	202	127	211	<b>220</b>	220	209	132
<b>LSA 46.3 M7</b> kVA	275	<b>275</b>	275	261	165	250	<b>250</b>	250	238	150	292	<b>292</b>	292	277	175	303	<b>303</b>	303	287	182
kW	220	<b>220</b>	220	209	132	200	<b>200</b>	200	190	120	234	<b>234</b>	234	222	140	242	<b>242</b>	242	230	146
<b>LSA 46.3 M8</b> kVA	290	<b>300</b>	300	285	180	264	<b>273</b>	273	259	164	307	<b>318</b>	318	302	191	319	<b>330</b>	330	313	200
kW	232	<b>240</b>	240	228	144	211	<b>218</b>	218	207	131	246	<b>254</b>	254	242	153	255	<b>264</b>	264	250	160
<b>LSA 46.3 L10</b> kVA	325	<b>325</b>	325	309	195	300	<b>300</b>	300	281	177	345	<b>345</b>	345	327	207	358	<b>358</b>	358	340	215
kW	260	<b>260</b>	260	247	156	240	<b>240</b>	240	225	142	276	<b>276</b>	276	262	166	286	<b>286</b>	286	272	172
<b>LSA 46.3 L11</b> kVA	350	<b>365</b>	365	347	210	319	<b>332</b>	332	316	191	371	<b>387</b>	387	368	225	385	<b>400</b>	400	380	231
kW	280	<b>292</b>	292	277	168	255	<b>266</b>	266	253	153	297	<b>310</b>	310	294	180	308	<b>320</b>	320	304	185

## Ratings 60 Hz - 1800 R.P.M.

kVA / kW - P.F. = 0.8																				
Duty/T°C	Continuous duty/40°C					Continuous duty/40°C					Stand-by/40°C				Stand-by/27°C					
Class/T°C	H/125°K					F/105°K					H/150°K				H/163°K					
Phase	3 ph.			1 ph.		3 ph.			1 ph.		3 ph.		1 ph.		3 ph.			1 ph.		
<b>Y</b>	380V	416V	440V	<b>480V</b>	ΔΔ	380V	416V	440V	<b>480V</b>	ΔΔ	380V	416V	440V	<b>480V</b>	ΔΔ	380V	416V	440V	<b>480V</b>	ΔΔ
<b>Δ</b>	220V	240V		240V		220V	240V		240V		220V	240V		240V		220V	240V		240V	
<b>YY</b>		208V	220V	<b>240V</b>			208V	220V	<b>240V</b>			208V	220V	<b>240V</b>			208V	220V	<b>240V</b>	
<b>LSA 46.3 S4</b> kVA	226	250	262	<b>288</b>	152	206	227	238	<b>262</b>	138	240	264	278	<b>305</b>	161	250	274	288	<b>316</b>	167
kW	181	200	210	<b>230</b>	122	165	182	190	<b>210</b>	110	192	211	222	<b>244</b>	129	200	219	230	<b>253</b>	134
<b>LSA 46.3 S5</b> kVA	245	265	280	<b>313</b>	165	223	241	255	<b>284</b>	150	260	281	297	<b>331</b>	175	270	292	308	<b>344</b>	182
kW	196	212	224	<b>250</b>	132	178	193	204	<b>227</b>	120	208	225	238	<b>265</b>	140	216	234	246	<b>275</b>	146
<b>LSA 46.3 M7</b> kVA	275	300	315	<b>344</b>	182	250	273	287	<b>313</b>	165	292	318	334	<b>364</b>	192	303	330	347	<b>378</b>	200
kW	220	240	252	<b>275</b>	146	200	218	230	<b>250</b>	132	234	254	267	<b>291</b>	154	242	264	278	<b>302</b>	160
<b>LSA 46.3 M8</b> kVA	290	315	340	<b>375</b>	200	264	287	309	<b>337</b>	180	307	334	360	<b>395</b>	210	319	347	375	<b>412</b>	218
kW	232	252	272	<b>300</b>	160	211	230	247	<b>270</b>	144	246	267	288	<b>316</b>	168	255	278	300	<b>330</b>	174
<b>LSA 46.3 L10</b> kVA	315	345	365	<b>406</b>	215	287	314	332	<b>370</b>	195	334	366	387	<b>431</b>	227	347	380	402	<b>447</b>	236
kW	252	276	292	<b>325</b>	172	230	251	266	<b>296</b>	156	267	293	310	<b>345</b>	182	278	304	322	<b>358</b>	189
<b>LSA 46.3 L11</b> kVA	360	393	419	<b>456</b>	231	328	358	381	<b>415</b>	210	382	417	444	<b>483</b>	250	396	432	461	<b>502</b>	254
kW	288	314	335	<b>365</b>	185	262	286	305	<b>332</b>	168	305	333	355	<b>386</b>	200	317	346	369	<b>402</b>	203

Efficiencies 400V - 50 Hz (— P.F.: 0.8) (--- P.F.: 1)

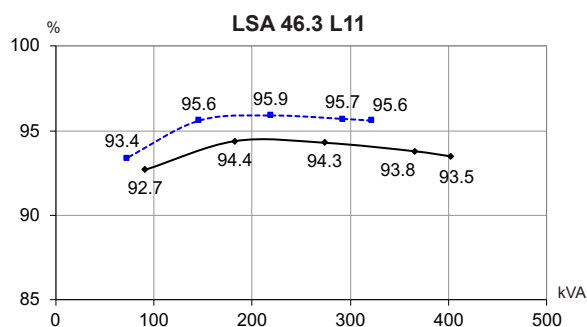
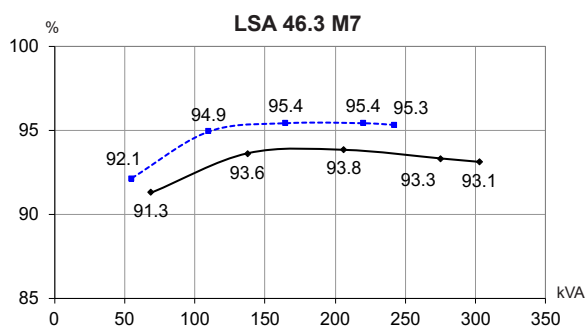
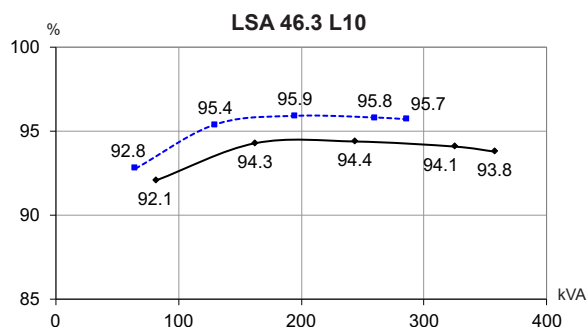
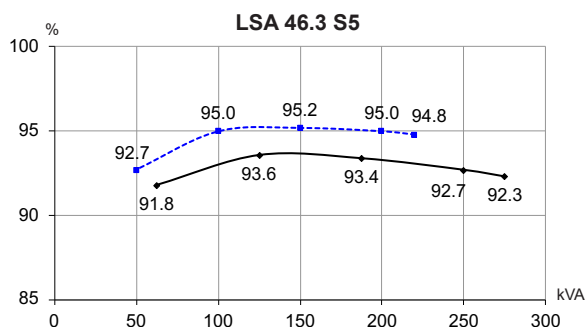
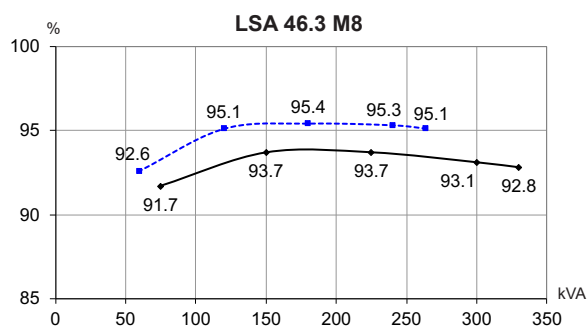
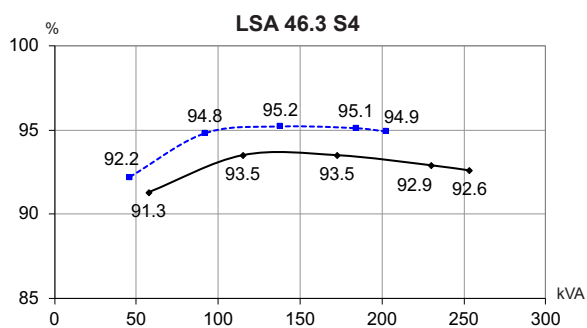

Reactances (%). Time constants (ms) - Class H / 400 V

	S4	S5	M7	M8	L10	L11
<b>Kcc</b> Short-circuit ratio	0.4	0.36	0.49	0.44	0.44	0.39
<b>Xd</b> Direct-axis synchronous reactance unsaturated	339	369	316	344	316	355
<b>Xq</b> Quadrature-axis synchronous reactance unsaturated	173	188	161	175	161	181
<b>T'do</b> No-load transient time constant	2452	2452	2543	2543	2686	2686
<b>X'd</b> Direct-axis transient reactance saturated	13.8	15	12.4	13.5	11.7	13.2
<b>T'd</b> Short-circuit transient time constant	100	100	100	100	100	100
<b>X''d</b> Direct-axis subtransient reactance saturated	11	12	9.9	10.8	9.4	10.5
<b>T''d</b> Subtransient time constant	10	10	10	10	10	10
<b>X''q</b> Quadrature-axis subtransient reactance saturated	14.6	15.9	13.1	14.3	12.6	14.1
<b>Xo</b> Zero sequence reactance	0.57	0.62	0.51	0.56	0.49	0.55
<b>X2</b> Negative sequence reactance saturated	12.86	13.98	11.57	12.62	11.01	12.37
<b>Ta</b> Armature time constant	15	15	15	15	15	15

Other class H / 400 V data

<b>io (A)</b> No-load excitation current (SHUNT/AREP)	0.78	0.78	0.94	0.94	0.81	0.81
<b>ic (A)</b> On-load excitation current (SHUNT/AREP)	3.06	3.32	3.14	3.41	2.94	3.29
<b>uc (V)</b> On-load excitation voltage (SHUNT/AREP)	41.4	44.6	46.2	49.7	42.8	47.5
<b>ms</b> Response time ( $\Delta U = 20\%$ transient)	500	500	500	500	500	500
<b>kVA</b> Start ( $\Delta U = 20\%$ cont. or 30% trans.) SHUNT	554	557	667	664	791	790
<b>kVA</b> Start ( $\Delta U = 20\%$ cont. or 30% trans.) AREP	639	640	736	738	876	880
<b>%</b> Transient $\Delta U$ (on-load 4/4) SHUNT - P.F.: 0.8 <sub>LAG</sub>	13.2	14	13.6	14.4	13.6	14.7
<b>%</b> Transient $\Delta U$ (on-load 4/4) AREP - P.F.: 0.8 <sub>LAG</sub>	12.4	13.1	12.7	13.5	12.6	13.7
<b>W</b> No-load losses	3660	3660	4449	4449	4775	4775
<b>W</b> Heat dissipation	13869	15662	15583	17615	16271	19169

Transient voltage variation 400V - 50 Hz

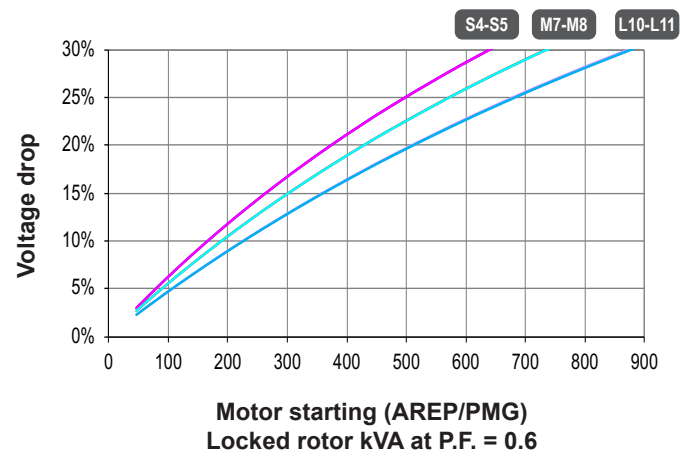
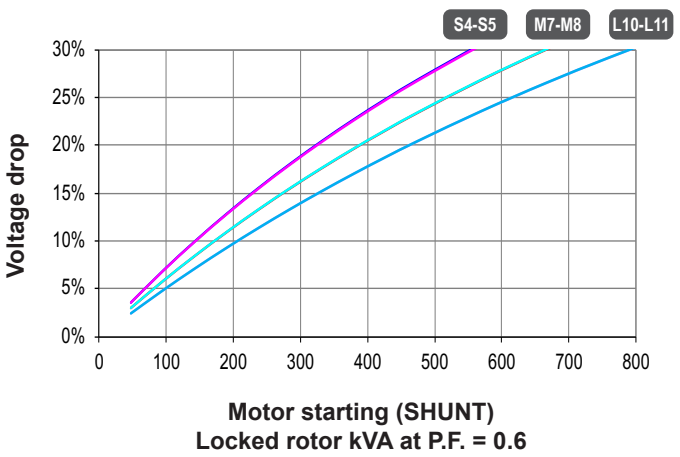
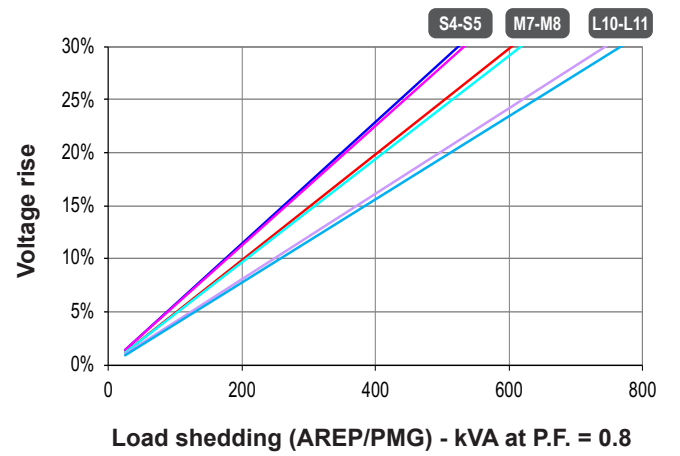
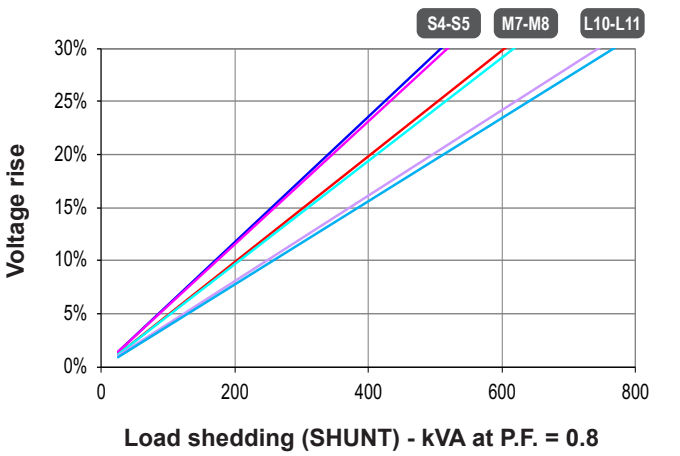
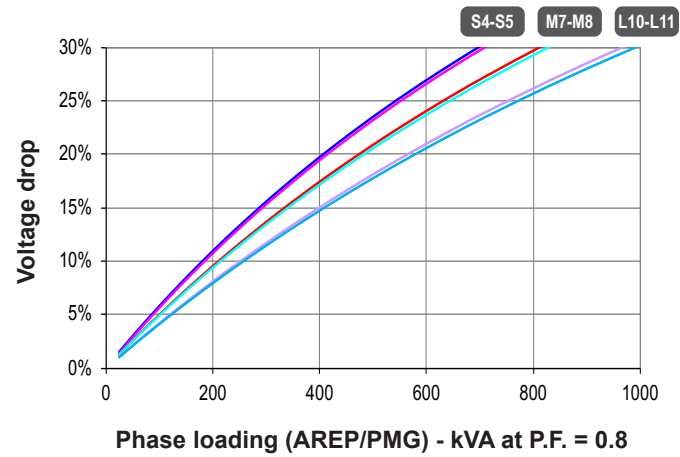
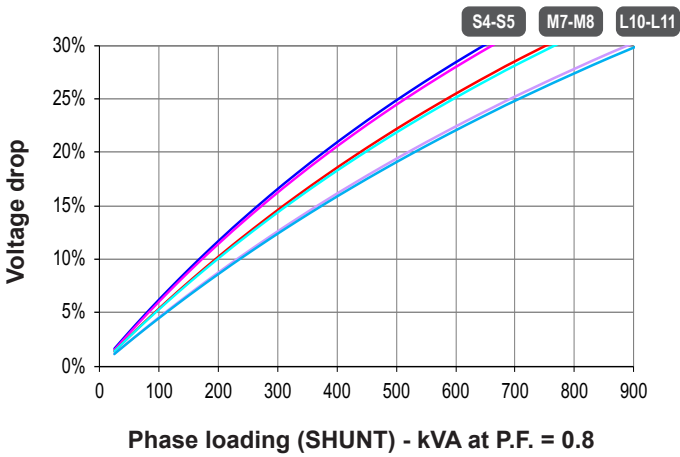

- 1) For a starting P.F. other than 0.6, the starting kVA must be multiplied by  $K = \text{Sine P.F.} / 0.6$
- 2) For voltages other than 400V (Y), 230V (Δ) at 50 Hz, then kVA must be multiplied by  $(400/U)^2$  or  $(230/U)^2$ .

Efficiencies 480V - 60 Hz (— P.F.: 0.8) (--- P.F.: 1)

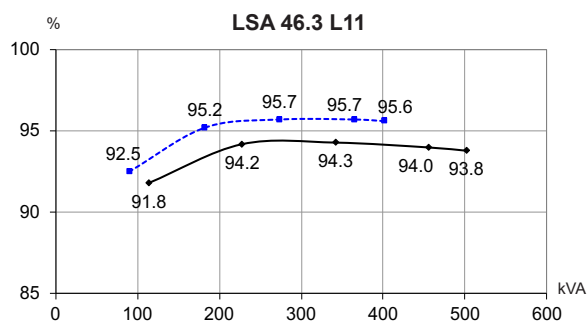
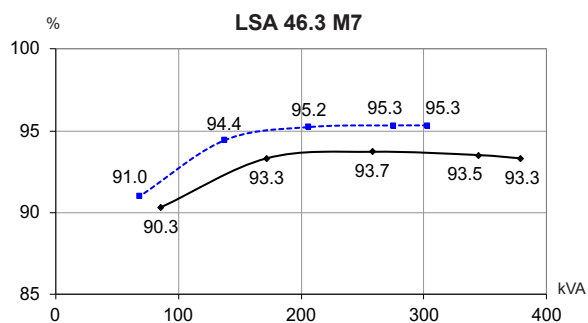
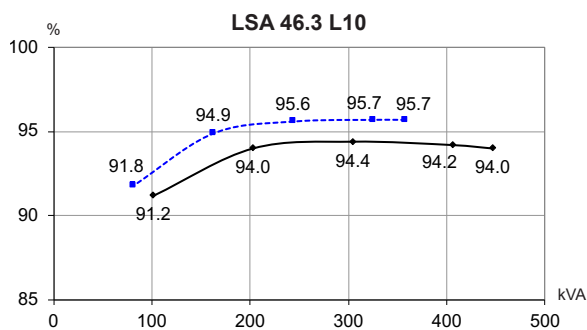
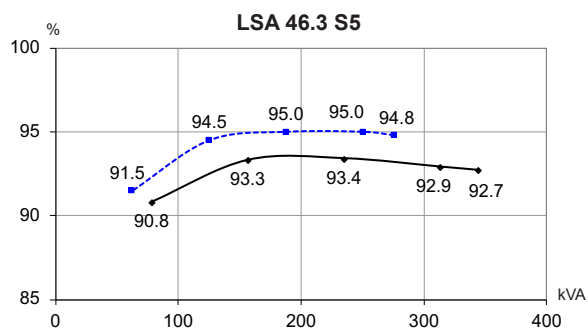
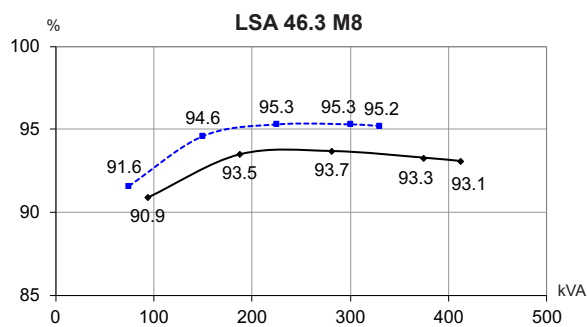
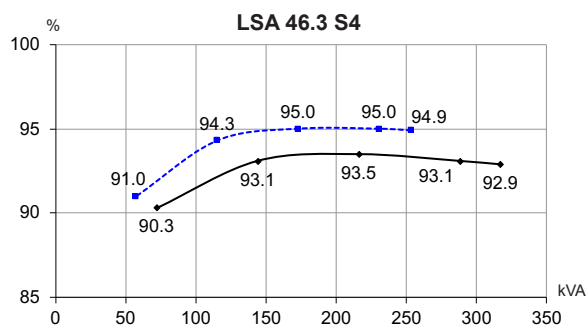

Reactances (%). Time constants (ms) - Class H / 480 V

	S4	S5	M7	M8	L10	L11
<b>Kcc</b> Short-circuit ratio	0.38	0.35	0.47	0.43	0.42	0.37
<b>Xd</b> Direct-axis synchronous reactance unsaturated	354	385	329	359	329	370
<b>Xq</b> Quadrature-axis synchronous reactance unsaturated	180	196	168	183	168	188
<b>T'do</b> No-load transient time constant	2452	2452	2543	2543	2686	2686
<b>X'd</b> Direct-axis transient reactance saturated	14.4	15.7	12.9	14.1	12.2	13.7
<b>T'd</b> Short-circuit transient time constant	100	100	100	100	100	100
<b>X''d</b> Direct-axis subtransient reactance saturated	11.5	12.5	10.3	11.2	9.8	11
<b>T''d</b> Subtransient time constant	10	10	10	10	10	10
<b>X''q</b> Quadrature-axis subtransient reactance saturated	15.2	16.6	13.7	14.9	13.1	14.1
<b>Xo</b> Zero sequence reactance	0.6	0.65	0.53	0.58	0.51	0.57
<b>X2</b> Negative sequence reactance saturated	13.42	14.58	12.06	13.14	11.46	12.87
<b>Ta</b> Armature time constant	15	15	15	15	15	15

Other class H / 480 V data

<b>io (A)</b> No-load excitation current (SHUNT/AREP)	0.78	0.78	0.94	0.94	0.81	0.81
<b>ic (A)</b> On-load excitation current (SHUNT/AREP)	3.05	3.3	3.13	3.38	2.92	3.26
<b>uc (V)</b> On-load excitation voltage (SHUNT/AREP)	41.7	44.9	46.5	50	43.1	47.7
<b>ms</b> Response time ( $\Delta U = 20\%$ transient)	500	500	500	500	500	500
<b>kVA</b> Start ( $\Delta U = 20\%$ cont. or 30% trans.) SHUNT	699	695	799	800	947	945
<b>kVA</b> Start ( $\Delta U = 20\%$ cont. or 30% trans.) AREP	765	766	887	883	1055	1053
<b>%</b> Transient $\Delta U$ (on-load 4/4) SHUNT - P.F.: 0.8 <sub>LAG</sub>	13.6	14.4	14	14.9	13.9	15.1
<b>%</b> Transient $\Delta U$ (on-load 4/4) AREP - P.F.: 0.8 <sub>LAG</sub>	12.8	13.5	13.1	13.8	13	14
<b>W</b> No-load losses	5549	5549	6617	6617	7115	7115
<b>W</b> Heat dissipation	16897	18905	18951	21212	19891	23158

Transient voltage variation 480V - 60 Hz

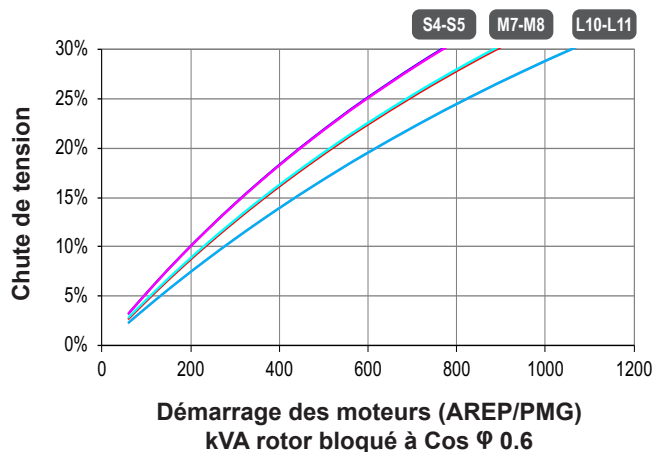
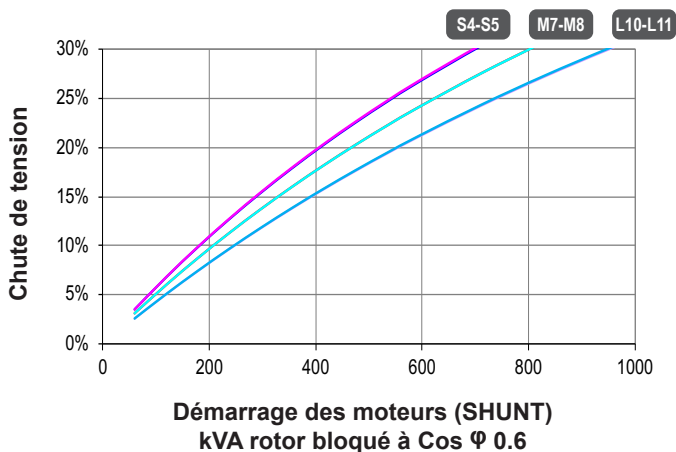
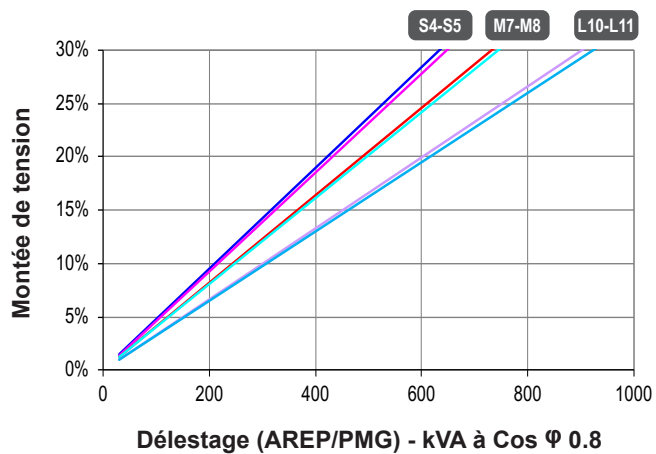
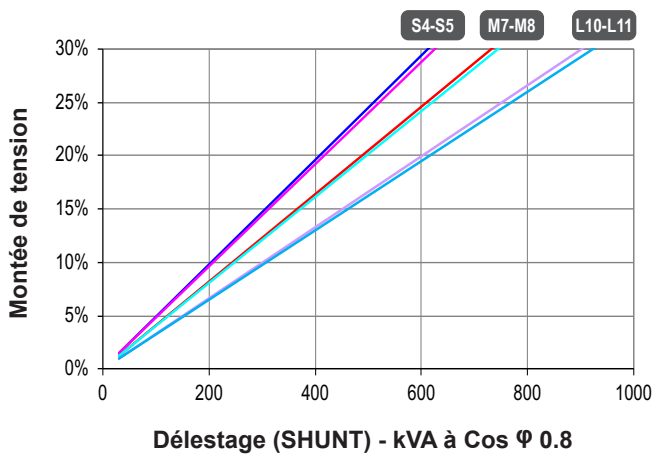
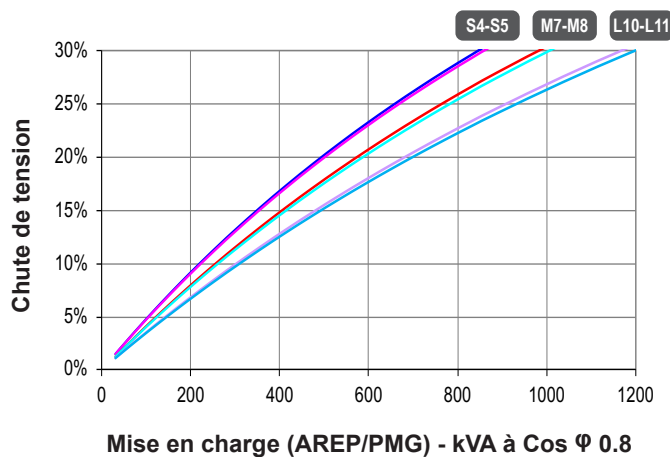
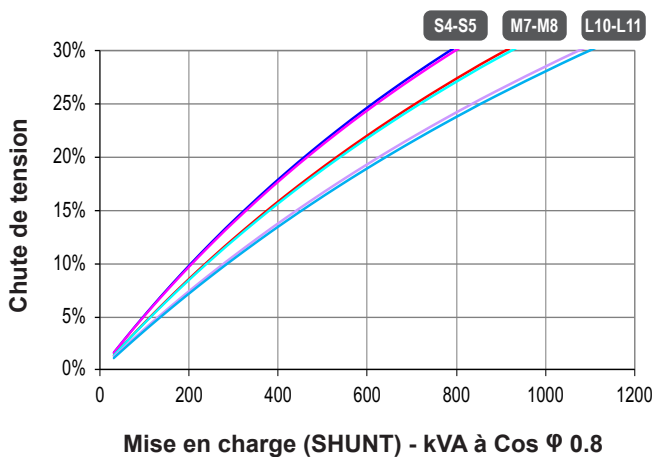

- 1) For a starting P.F. other than 0.6, the starting kVA must be multiplied by  $K = \text{Sine P.F.} / 0.6$
- 2) For voltages other than 480V (Y), 277V (Δ), 240V (YY) at 60 Hz, then kVA must be multiplied by  $(480/U)^2$  or  $(277/U)^2$  or  $(240/U)^2$ .

3-phase short-circuit curves at no load and rated speed (star connection Y)

LSA 46.3 S4

Symmetrical —  
Asymmetrical - - -

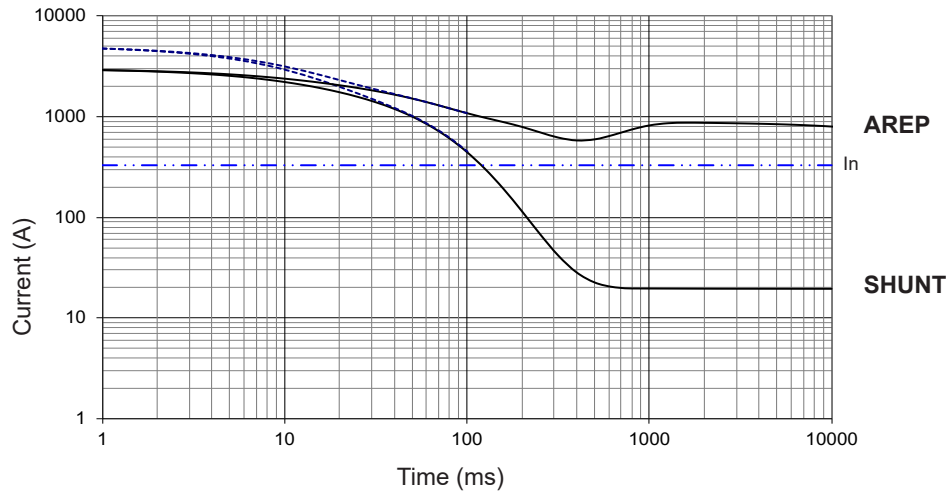

LSA 46.3 S5

Symmetrical —  
Asymmetrical - - -

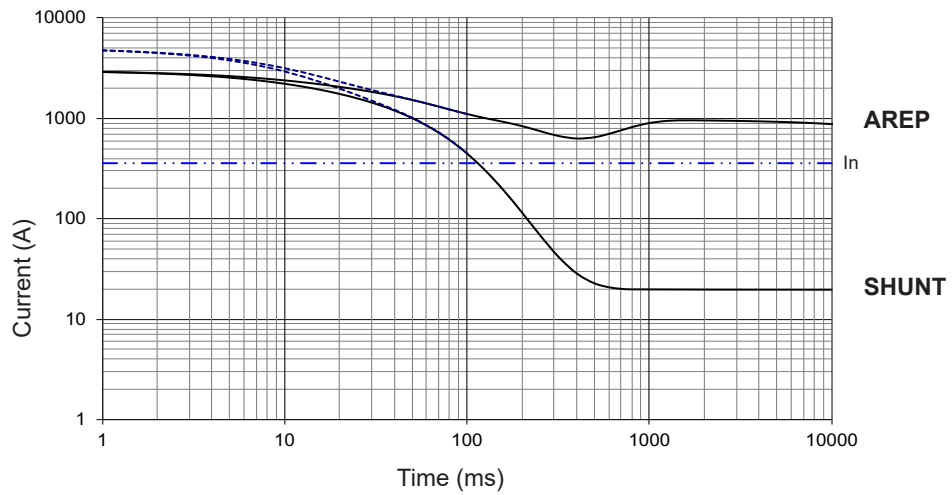

LSA 46.3 M7

Symmetrical —  
Asymmetrical - - -

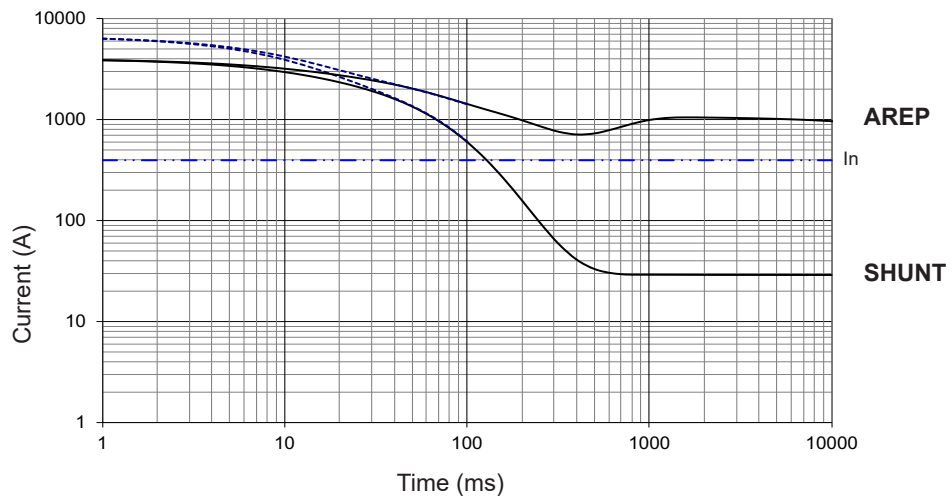

Influence due to connection

Curves shown are for star (Y) connection.

For other connections, use the following multiplication factors:

- Series delta : current value x 1.732 - Parallel star : current value x 2



3-phase short-circuit curves at no load and rated speed (star connection Y)

LSA 46.3 M8

Symmetrical —  
Asymmetrical - - -

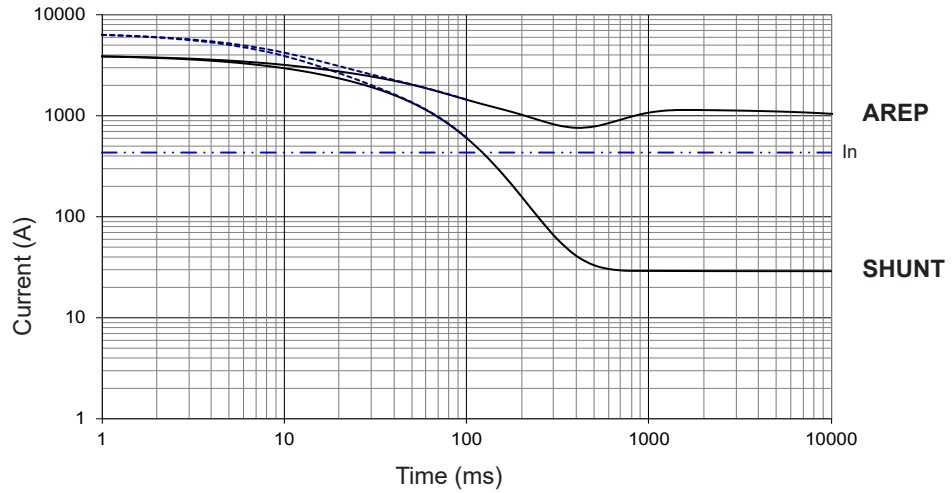

LSA 46.3 L10

Symmetrical —  
Asymmetrical - - -

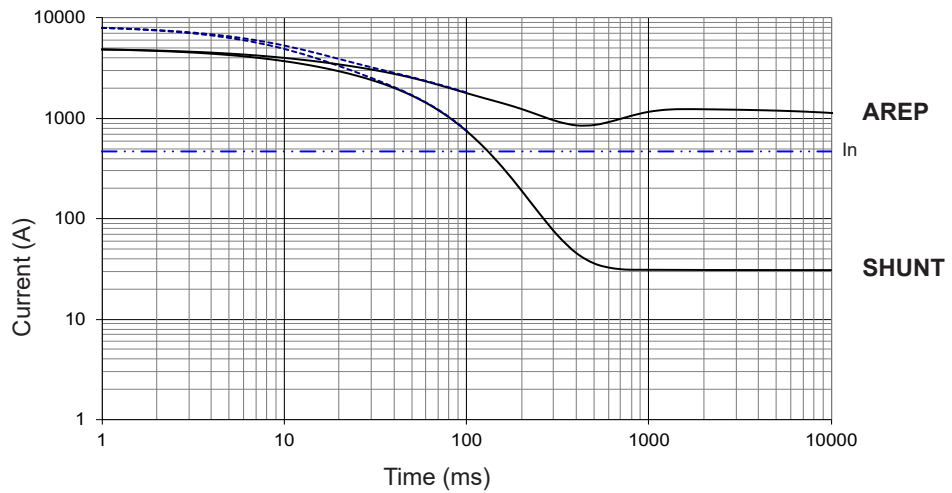

LSA 46.3 L11

Symmetrical —  
Asymmetrical - - -

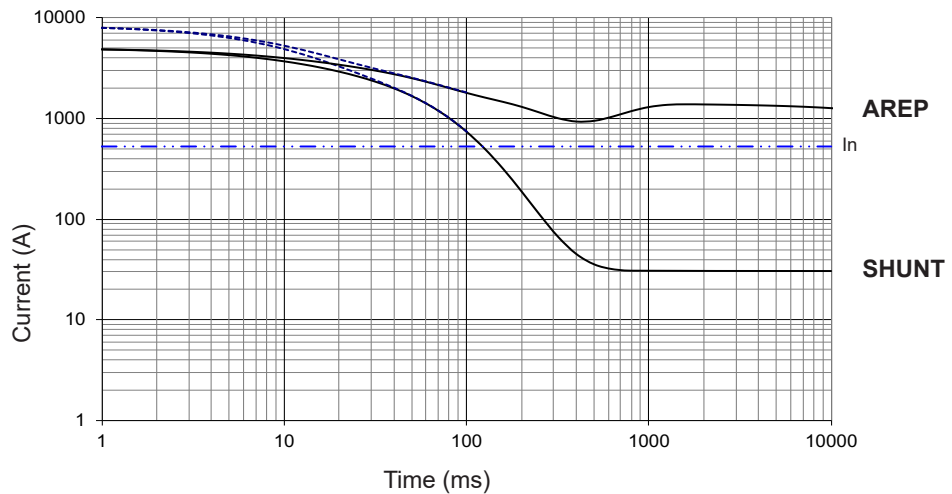

**Influence due to short-circuit**

Curves are based on a three-phase short-circuit.

For other types of short-circuit, use the following multiplication factors.

	3-phase	2-phase L/L	1-phase L/N
Instantaneous (max.)	1	0.87	1.3
Continuous	1	1.5	2.2
Maximum duration (AREP/PMG)	10 sec.	5 sec.	2 sec.

### Single-bearing dimensions

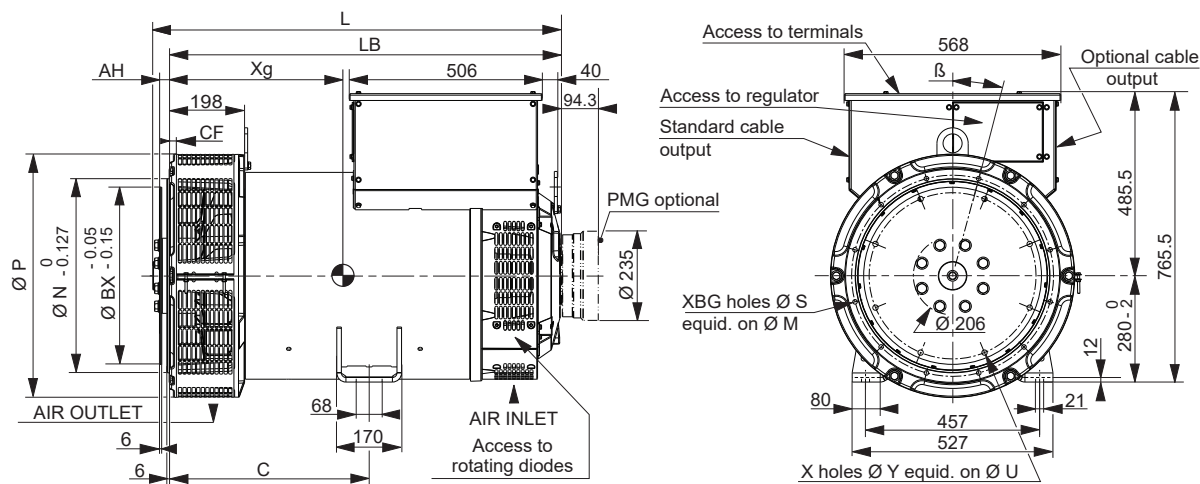

Dimensions (mm) and weight						Coupling			
Type	L without PMG maxi*	LB	Xg	C	Weight (kg)	Flex plate	11 ½	14	18
LSA 46.3 S4	944	892	423	429	674	Flange S.A.E 3	X		
LSA 46.3 S5	944	892	423	429	682	Flange S.A.E 2	X		
LSA 46.3 M7	989	937	445	429	754	Flange S.A.E 1	X	X	
LSA 46.3 M8	989	937	445	429	754	Flange S.A.E ½		X	
LSA 46.3 L10**	1084	1032	493	525	888	Flange S.A.E 0		X	X
LSA 46.3 L11**	1084	1032	493	525	888			X	X

\* L maxi = LB + AH maxi + 12.4 (only for SAE 11 ½) \*\* Shaft height = 355 mm optional

Flange (mm)								Flex plate (mm)					
S.A.E.	P	N	M	XBG	S	β°	CF	S.A.E.	BX	U	X	Y	AH
3	600*/641	409.575	428.625	12	11	15°	10	11 ½	352.42	333.38	8	11	39.6
2	600*/641	447.675	466.725	12	11	15°	10	14	466.72	438.15	8	14	25.4
1	600*/641	511.175	530.225	12	12	15°	10	18*	571.5	542.92	6	17	15.7
½	713	584.2	619.125	12	14	15°	6						
0	713	647.7	679.45	16	14	11° 15'	19						

\* Specific dimension LSA 46.3 S4

### Torsional analysis data

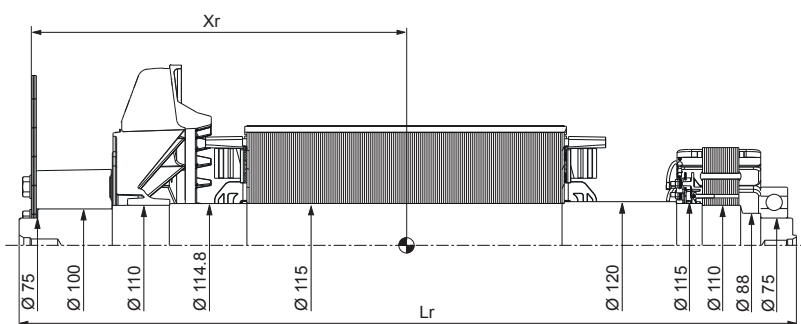

Centre of gravity: Xr (mm), Rotor length: Lr (mm), Weight: M (kg), Moment of inertia: J (kgm²): (4J = MD²)									
Flex plate	S.A.E. 11 ½				S.A.E. 14				
	Type	Xr	Lr	M	J	Xr	Lr	M	J
LSA 46.3 S4		431	928	277	2.93	416	928	277	3.09
LSA 46.3 S5		431	928	277	2.93	416	928	277	3.09
LSA 46.3 M7		459	973	307	3.23	444	973	307	3.39
LSA 46.3 M8		459	973	307	3.32	444	973	307	3.39
LSA 46.3 L10		507	1068	362	3.96	493	1068	362	4.12
LSA 46.3 L11		507	1068	362	3.96	493	1068	362	4.12

**NOTE :** Dimensions are for information only and may be subject to modifications. Contractual 2D drawings can be downloaded from the Leroy-Somer site, 3D drawing files are available upon request. The torsional analysis of the transmission is imperative. All values are available upon request.

## Two-bearing dimensions

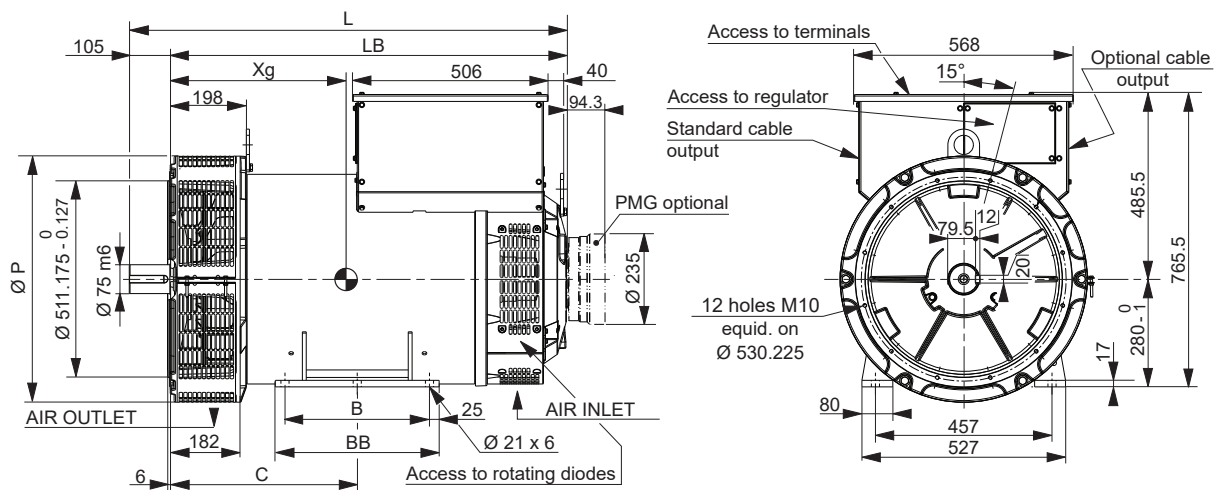

Dimensions (mm) and weight

Type	L without PMG	LB	C	BB	B	P	Xg	Weight (kg)
LSA 46.3 S4	997	892	389	368	318	600	427	674
LSA 46.3 S5	997	892	389	368	318	640	427	682
LSA 46.3 M7	1042	937	389	368	318	640	449	754
LSA 46.3 M8	1042	937	389	368	318	640	449	754
LSA 46.3 L10	1137	1032	485	424	374	640	496	888
LSA 46.3 L11	1137	1032	485	424	374	640	496	888

## Torsional analysis data

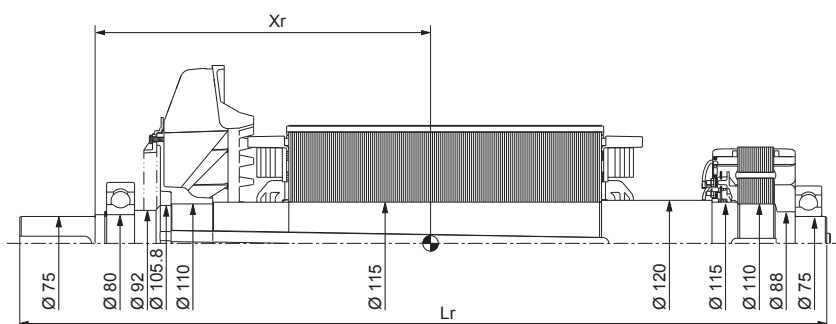

Centre of gravity:  $X_r$  (mm), Rotor length:  $L_r$  (mm), Weight:  $M$  (kg), Moment of inertia:  $J$  ( $\text{kgm}^2$ ): ( $4J = MD^2$ )

Type	$X_r$	$L_r$	$M$	$J$
LSA 46.3 S4	430	990	250	2.76
LSA 46.3 S5	430	990	250	2.76
LSA 46.3 M7	456	1035	280	3.09
LSA 46.3 M8	456	1035	280	3.09
LSA 46.3 L10	503	1130	336	3.79
LSA 46.3 L11	503	1130	336	3.79

**NOTE :** Dimensions are for information only and may be subject to modifications. Contractual 2D drawings can be downloaded from the Leroy-Somer site, 3D drawing files are available upon request.  
The torsional analysis of the transmission is imperative. All values are available upon request.

**LEROY-SOMER**<sup>™</sup>

[www.leroy-somer.com/epg](http://www.leroy-somer.com/epg)

Connect with us at:



***Nidec***  
All for dreams

© 2024 Moteurs Leroy-Somer SAS. The information contained in this brochure is for guidance only and does not form part of any contract. The accuracy cannot be guaranteed as Moteurs Leroy-Somer SAS have an ongoing process of development and reserve the right to change the specification of their products without notice.

Moteurs Leroy-Somer SAS. Headquarters: Bd Marcellin Leroy, CS 10015, 16915 Angoulême Cedex 9, France. Share Capital: 32,239,235 €, RCS Angoulême 338 567 258.