

## LSA 49.3

### Low Voltage Alternator - 4 pole

660 to 1000 kVA - 50 Hz / 825 to 1250 kVA - 60 Hz  
Electrical and mechanical data

LEROY-SOMER™

**Nidec**  
All for dreams

## The best of performance

Nidec Leroy-Somer LSA 49.3 alternator has been designed to offer you the best power generation performances. With its meticulous design and optimized architecture, the LSA 49.3 strikes the perfect balance between compactness, reliability, performance and longevity.

Whatever your application, the LSA 49.3 will meet your needs and will adapt to all situations.

## Standards

Nidec Leroy-Somer LSA 49.3 alternator meets all key international standards and regulations, including IEC 60034, NEMA MG 1.32-33, ISO 8528-3, CSA C22.2 n°100-14 and UL 1446 (UL 1004 on request). Also compliant with IEC 61000-6-2, IEC 61000-6-3, IEC 61000-6-4, VDE 0875G, VDE 0875N and EN 55011, group 1 class A for European zone.

Nidec Leroy-Somer LSA 49.3 alternator can be integrated in EC marked generator set, and bears EC, UKCA and CMIM markings. It is designed, manufactured and marketed in an ISO 9001 and ISO 14001 quality assurance environment.

## Electrical characteristics and performances

- Class H insulation
- 2/3 pitch winding, standard 6-wire (6S) reconnectable or 12-wire (6) optional
- Voltage range:
  - 50 Hz: 220V - 240V and 380V - 415V (440V)
  - 60 Hz: 208V - 240V and 380V - 480V
- High efficiency and motor starting capacity
- Other voltages are possible with optional adapted windings:
  - 50 Hz: 440V (no. 7), 500V (no. 9), 550V (no. 22), 600V (no. 23), 690V (no. 10)
  - 60 Hz: 380V and 416V (no. 8), 600V (no. 9), 690V (no. 22)

## Excitation and regulation system

Excitation system			Regulation options		
AVR	AREP	PMG (option)	C.T. Current transformer for paralleling	Mains paralleling	Remote voltage potentiometer
D350	Standard	Standard	√		√
D550	Option	Option	√	√	√

3-phase sensing is included as a standard with digital regulators.

## Protection system and options

- The LSA 49.3 is IP 23
- Complete winding protection for clean environments with relative humidity  $\leq 95\%$ , including indoor marine environments
- Options:
  - Filters on air inlet: derating 5%
  - Filters on air inlet and air outlet (IP 44): derating 10%
  - Reinforced winding protection for harsh environments and relative humidity greater than 95%
  - Space heater
  - Thermal protection for stator windings and shields

## Mechanical construction

- Compact and rigid assembly to better withstand generator vibrations
- Steel frame
- Cast iron flanges and shields
- Two-bearing and single-bearing versions designed to be suitable for engines on the market
- Half-key balancing
- Greased for life bearings, regreasable bearings (optional)
- Standard direction of rotation: clockwise when looking at the drive end view (for anti-clockwise, derate the machine by 5%)

## Terminal box design

- Easy access to the voltage regulator and to the connections
- Possible inclusion of accessories for paralleling, protection and measurement
- Connection bars for voltage reconnection

### General characteristics

Insulation class	H	Excitation system	AREP / PMG
Winding pitch	2/3 (wind.6S - 6-wire / wind.6 - 12-wire option)	AVR type	D350
Number of wires	6 (12 option)	Voltage regulation (*)	± 0.25%
Protection	IP 23	Short-circuit current	300% (3 IN) : 10s
Altitude	≤ 1000 m	Total Harmonic distortion THD (**)	at no load < 4% - on load < 4%
Overspeed	2250 R.P.M.	Waveform: NEMA = TIF (**)	< 50
Air flow	1 m <sup>3</sup> /s (50 Hz) / 1.2 m <sup>3</sup> /s (60 Hz)	Waveform: IEC = THF (**)	< 2%

(\*) Steady state (\*\*) Total harmonic distortion between phases, no-load or on-load (non-distorting)

### Ratings 50 Hz - 1500 R.P.M.

kVA / kW - P.F. = 0.8																
Duty/T°C	Continuous duty/40°C				Continuous duty/40°C				Stand-by/40°C				Stand-by/27°C			
Class/T°K	H/125°K				F/105°K				H/150°K				H/163°K			
Phase	3 ph.				3 ph.				3 ph.				3 ph.			
<b>Y</b>	380V	<b>400V</b>	415V	440V	380V	<b>400V</b>	415V	440V	380V	<b>400V</b>	415V	440V	380V	<b>400V</b>	415V	440V
<b>Δ</b>	220V	<b>230V</b>	240V		220V	<b>230V</b>	240V		220V	<b>230V</b>	240V		220V	<b>230V</b>	240V	
<b>YY</b>		<b>200V</b>	220V			<b>200V</b>	220V			<b>200V</b>	220V			<b>200V</b>	220V	
<b>LSA 49.3 S4</b> kVA	660	<b>660</b>	660	620	595	<b>595</b>	595	560	725	<b>725</b>	725	685	745	<b>745</b>	745	715
kW	528	<b>528</b>	528	496	476	<b>476</b>	476	448	580	<b>580</b>	580	548	596	<b>596</b>	596	572
<b>LSA 49.3 M6</b> kVA	730	<b>730</b>	730	665	660	<b>660</b>	660	600	780	<b>780</b>	780	730	810	<b>810</b>	810	765
kW	584	<b>584</b>	584	532	528	<b>528</b>	528	480	624	<b>624</b>	624	584	648	<b>648</b>	648	612
<b>LSA 49.3 M8</b> kVA	820	<b>820</b>	820	810	760	<b>760</b>	760	710	910	<b>910</b>	910	885	945	<b>945</b>	945	925
kW	656	<b>656</b>	656	648	608	<b>608</b>	608	568	728	<b>728</b>	728	708	756	<b>756</b>	756	740
<b>LSA 49.3 L9</b> kVA	910	<b>910</b>	910	820	820	<b>820</b>	820	740	1000	<b>1000</b>	1000	920	1020	<b>1020</b>	1020	965
kW	728	<b>728</b>	728	656	656	<b>656</b>	656	592	800	<b>800</b>	800	736	816	<b>816</b>	816	772
<b>LSA 49.3 L10</b> kVA	1000	<b>1000</b>	1000	950	900	<b>900</b>	900	840	1085	<b>1085</b>	1085	1030	1130	<b>1130</b>	1130	1080
kW	800	<b>800</b>	800	760	720	<b>720</b>	720	672	868	<b>868</b>	868	824	904	<b>904</b>	904	864

### Ratings 60 Hz - 1800 R.P.M.

kVA / kW - P.F. = 0.8																
Duty/T°C	Continuous duty/40°C				Continuous duty/40°C				Stand-by/40°C				Stand-by/27°C			
Class/T°K	H/125°K				F/105°K				H/150°K				H/163°K			
Phase	3 ph.				3 ph.				3 ph.				3 ph.			
<b>Y</b>	380V	416V	440V	<b>480V</b>	380V	416V	440V	<b>480V</b>	380V	416V	440V	<b>480V</b>	380V	416V	440V	<b>480V</b>
<b>Δ</b>	220V	240V			220V	240V			220V	240V			220V	240V		
<b>YY</b>		208V	220V	<b>240V</b>		208V	220V	<b>240V</b>		208V	220V	<b>240V</b>		208V	220V	<b>240V</b>
<b>LSA 49.3 S4</b> kVA	653	715	756	<b>825</b>	588	644	681	<b>743</b>	693	758	802	<b>875</b>	718	787	832	<b>908</b>
kW	522	572	605	<b>660</b>	470	515	545	<b>594</b>	554	606	642	<b>700</b>	574	630	666	<b>726</b>
<b>LSA 49.3 M6</b> kVA	725	795	840	<b>915</b>	655	715	760	<b>825</b>	770	845	890	<b>970</b>	800	875	925	<b>1005</b>
kW	580	636	672	<b>732</b>	524	572	608	<b>660</b>	616	676	712	<b>776</b>	640	700	740	<b>804</b>
<b>LSA 49.3 M8</b> kVA	815	890	940	<b>1025</b>	735	805	850	<b>925</b>	865	945	1000	<b>1090</b>	895	980	1040	<b>1130</b>
kW	652	712	752	<b>820</b>	588	644	680	<b>740</b>	692	756	800	<b>872</b>	716	784	832	<b>904</b>
<b>LSA 49.3 L9</b> kVA	905	990	1045	<b>1140</b>	815	895	940	<b>1025</b>	960	1050	1110	<b>1210</b>	1000	1090	1155	<b>1255</b>
kW	724	792	836	<b>912</b>	652	716	752	<b>820</b>	768	840	888	<b>968</b>	800	872	924	<b>1004</b>
<b>LSA 49.3 L10</b> kVA	990	1083	1146	<b>1250</b>	891	975	1031	<b>1125</b>	1049	1148	1215	<b>1325</b>	1089	1192	1260	<b>1375</b>
kW	792	866	917	<b>1000</b>	713	780	825	<b>900</b>	839	918	972	<b>1060</b>	871	954	1008	<b>1100</b>

Efficiencies 400V - 50 Hz (— P.F.: 0.8) (--- P.F.: 1)

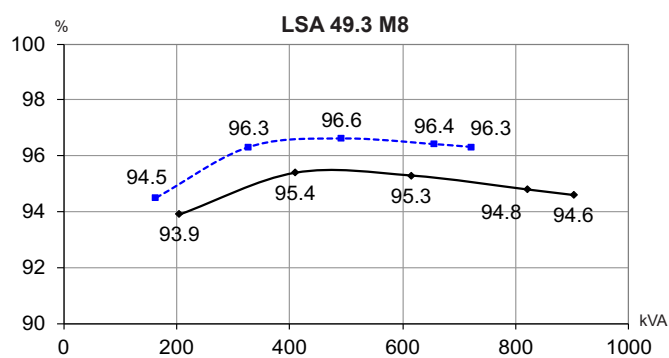
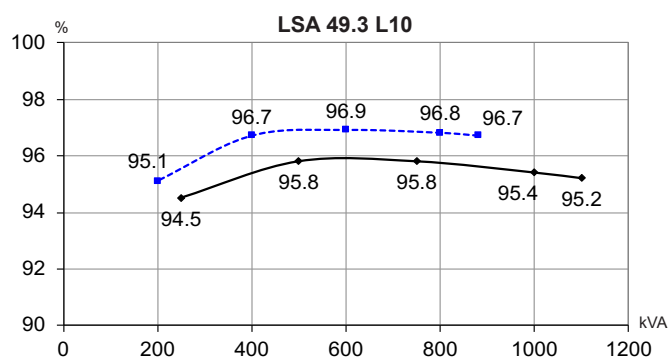
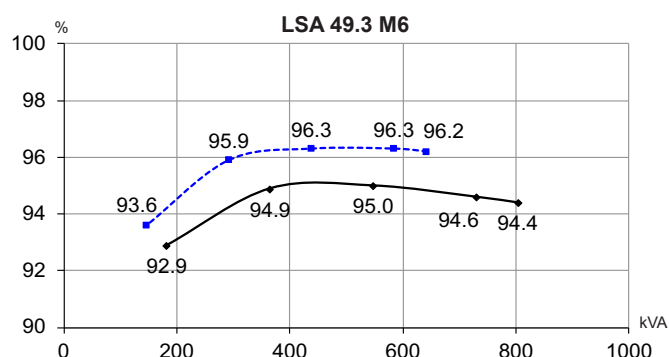
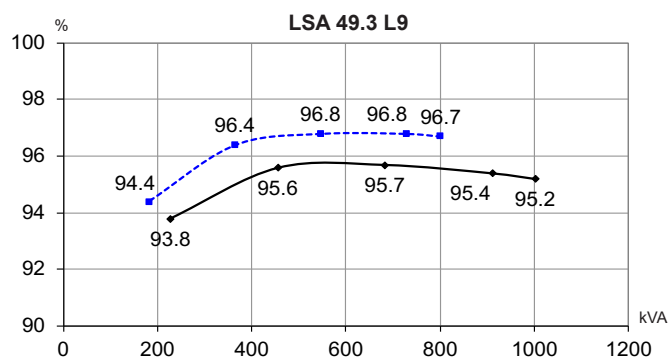
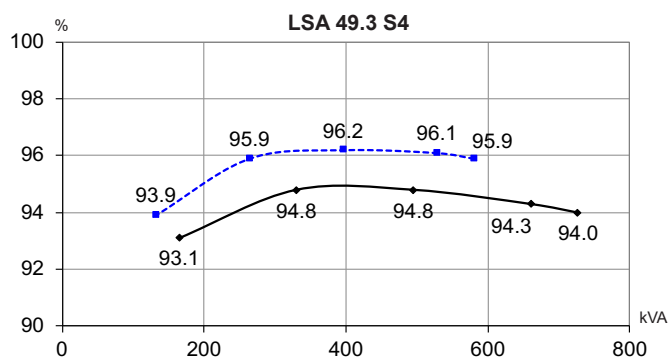

Reactances (%). Time constants (ms) - Class H / 400 V

	S4	M6	M8	L9	L10
<b>Kcc</b> Short-circuit ratio	0.33	0.42	0.34	0.41	0.34
<b>Xd</b> Direct-axis synchronous reactance unsaturated	350	294	348	303	348
<b>Xq</b> Quadrature-axis synchronous reactance unsaturated	178	150	177	154	177
<b>T'do</b> No-load transient time constant	2002	2074	2094	2138	2153
<b>X'd</b> Direct-axis transient reactance saturated	17.5	14.2	16.6	14.1	16.1
<b>T'd</b> Short-circuit transient time constant	100	100	100	100	100
<b>X''d</b> Direct-axis subtransient reactance saturated	14	11.3	13.3	11.3	12.9
<b>T''d</b> Subtransient time constant	10	10	10	10	10
<b>X''q</b> Quadrature-axis subtransient reactance saturated	16.3	12.8	14.9	12.4	14.1
<b>Xo</b> Zero sequence reactance	0.72	0.59	0.69	0.59	0.67
<b>X2</b> Negative sequence reactance saturated	15.17	12.1	14.11	11.92	13.53
<b>Ta</b> Armature time constant	15	15	15	15	15

Other class H / 400 V data

<b>io (A)</b> No-load excitation current	0.99	1.11	0.87	0.99	0.9
<b>ic (A)</b> On-load excitation current	4.04	3.8	3.52	3.46	3.62
<b>uc (V)</b> On-load excitation voltage	46	43.2	39.9	39.1	40.9
<b>ms</b> Response time ( $\Delta U = 20\%$ transient)	500	500	500	500	500
<b>kVA</b> Start ( $\Delta U = 20\%$ cont. or 30% trans.)	1560	2050	2050	2600	2600
<b>%</b> Transient $\Delta U$ (on-load 4/4) - P.F.: 0.8 <sub>LAG</sub>	14.4	12.6	14.2	12.2	13.6
<b>W</b> No-load losses	7968	9374	8753	10104	9556
<b>W</b> Heat dissipation	31765	32819	35599	34562	38447

Transient voltage variation 400V - 50 Hz

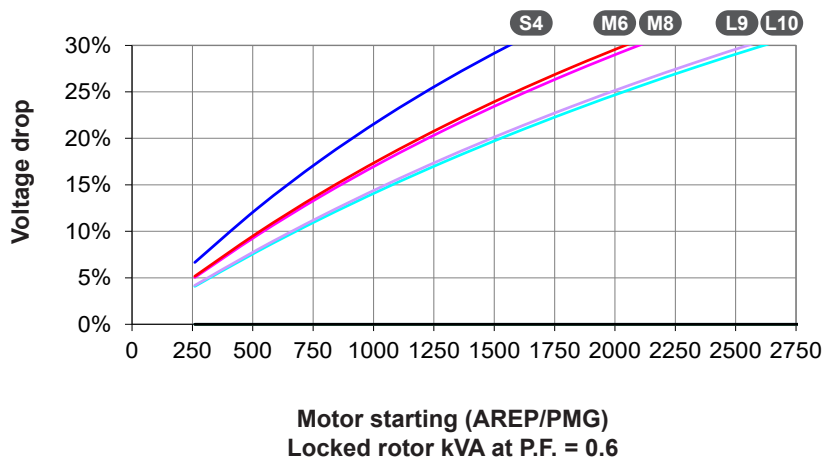
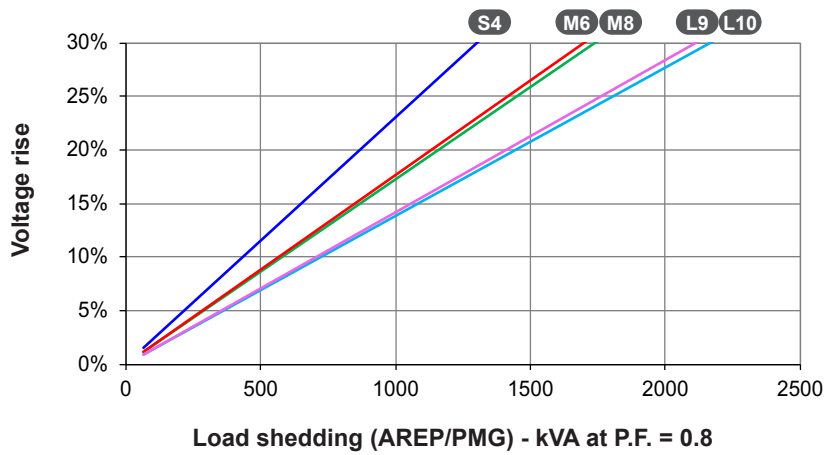
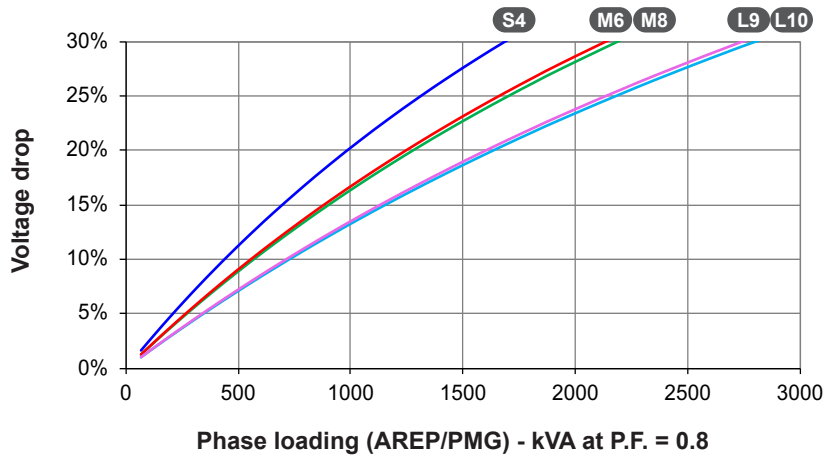

- 1) For a starting P.F. other than 0.6, the starting kVA must be multiplied by  $K = \text{Sine P.F.} / 0.8$
- 2) For voltages other than 400V (Y), 230V(Δ) at 50 Hz, then kVA must be multiplied by  $(400/U)^2$  or  $(230/U)^2$ .

Efficiencies 480V - 60 Hz (— P.F.: 0.8) (--- P.F.: 1)

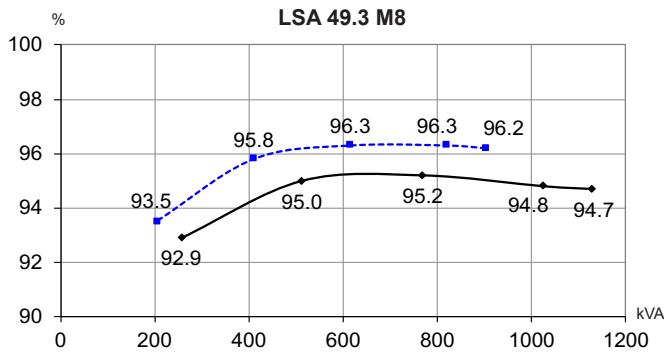
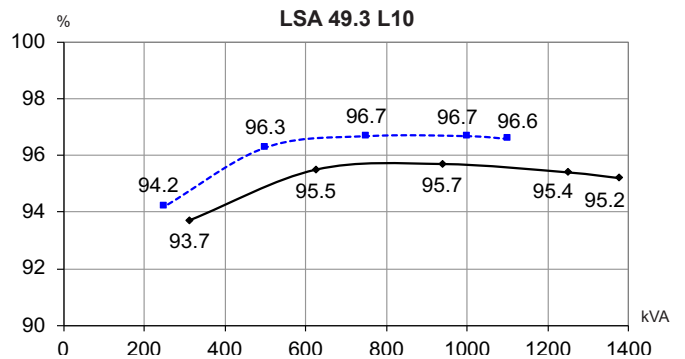
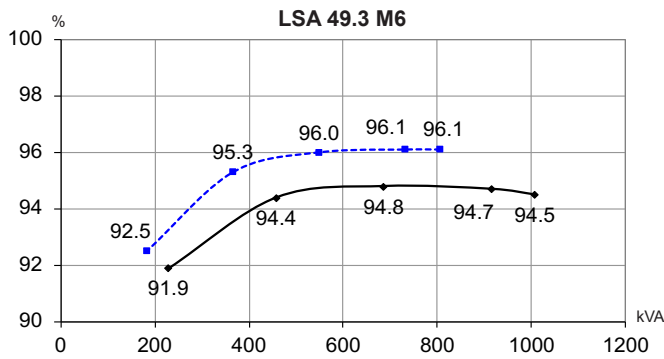
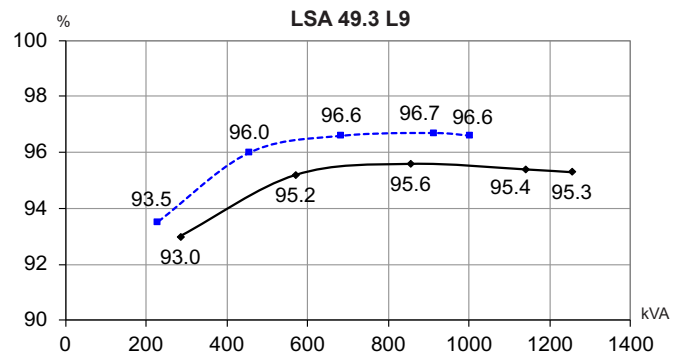
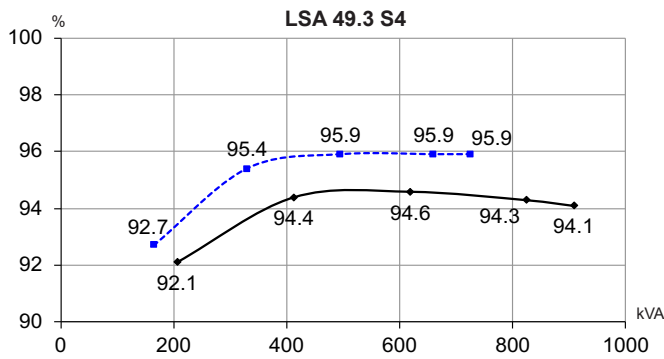

Reactances (%). Time constants (ms) - Class H / 480 V

	S4	M6	M8	L9	L10
<b>Kcc</b> Short-circuit ratio	0.32	0.4	0.32	0.4	0.33
<b>Xd</b> Direct-axis synchronous reactance unsaturated	365	307	362	317	363
<b>Xq</b> Quadrature-axis synchronous reactance unsaturated	186	156	185	161	185
<b>T'do</b> No-load transient time constant	2002	2074	2094	2138	2153
<b>X'd</b> Direct-axis transient reactance saturated	18.2	14.8	17.3	14.8	16.8
<b>T'd</b> Short-circuit transient time constant	100	100	100	100	100
<b>X''d</b> Direct-axis subtransient reactance saturated	14.5	11.8	13.8	11.8	13.4
<b>T''d</b> Subtransient time constant	10	10	10	10	10
<b>X''q</b> Quadrature-axis subtransient reactance saturated	17	13.4	15.5	13	14.7
<b>Xo</b> Zero sequence reactance	0.76	0.61	0.72	0.61	0.7
<b>X2</b> Negative sequence reactance saturated	15.8	12.64	14.7	12.44	14.1
<b>Ta</b> Armature time constant	15	15	15	15	15

Other class H / 480 V data

	S4	M6	M8	L9	L10
<b>io (A)</b> No-load excitation current	0.99	1.11	0.87	0.99	0.9
<b>ic (A)</b> On-load excitation current	4.14	3.89	3.6	3.53	3.69
<b>uc (V)</b> On-load excitation voltage	47.3	44.4	41	40.2	41.9
<b>ms</b> Response time ( $\Delta U = 20\%$ transient)	500	500	500	500	500
<b>kVA</b> Start ( $\Delta U = 20\%$ cont. or 30% trans.)	1950	2565	2565	3250	3250
<b>%</b> Transient $\Delta U$ (on-load 4/4) - P.F.: 0.8 <sub>LAG</sub>	14.9	13	14.7	12.7	14
<b>W</b> No-load losses	12441	14387	13586	15384	14640
<b>W</b> Heat dissipation	39236	40967	44074	43239	47530

Transient voltage variation 480V - 60 Hz

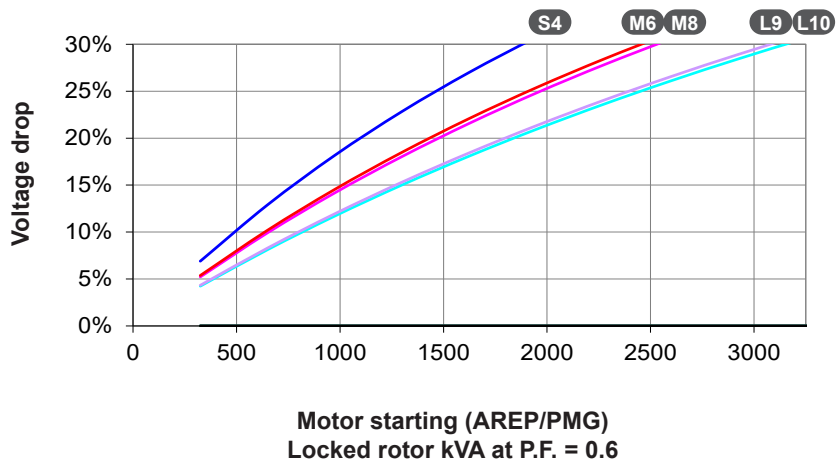
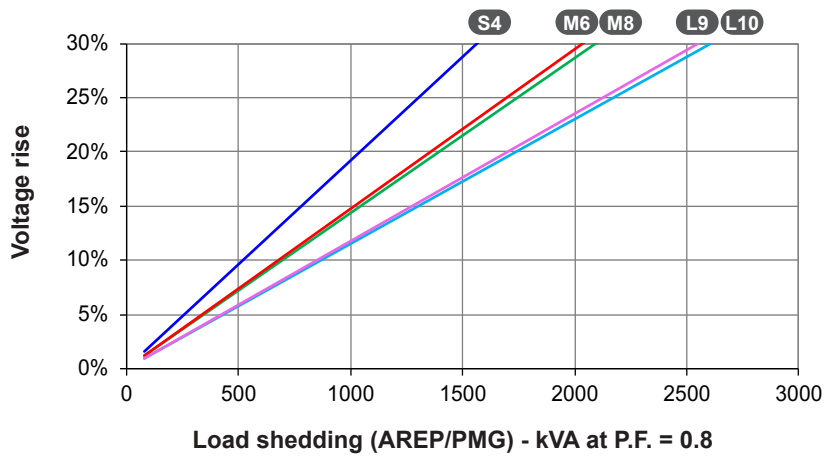
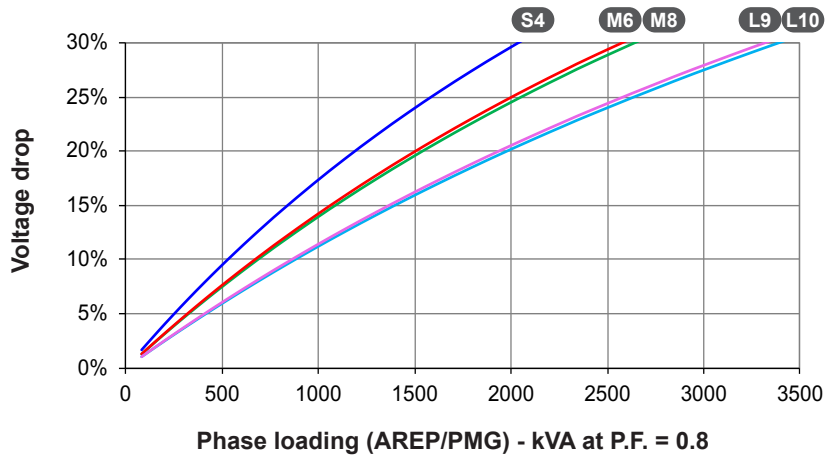

- 1) For a starting P.F. other than 0.6, the starting kVA must be multiplied by  $K = \text{Sine P.F.} / 0.8$
- 2) For voltages other than 480V (Y), 277V ( $\Delta$ ), 240V (YY) at 60 Hz, then kVA must be multiplied by  $(480/U)^2$  or  $(277/U)^2$  or  $(240/U)^2$ .

3-phase short-circuit curves at no load and rated speed (star connection Y)

LSA 49.3 S4

Symmetrical —  
Asymmetrical - - -

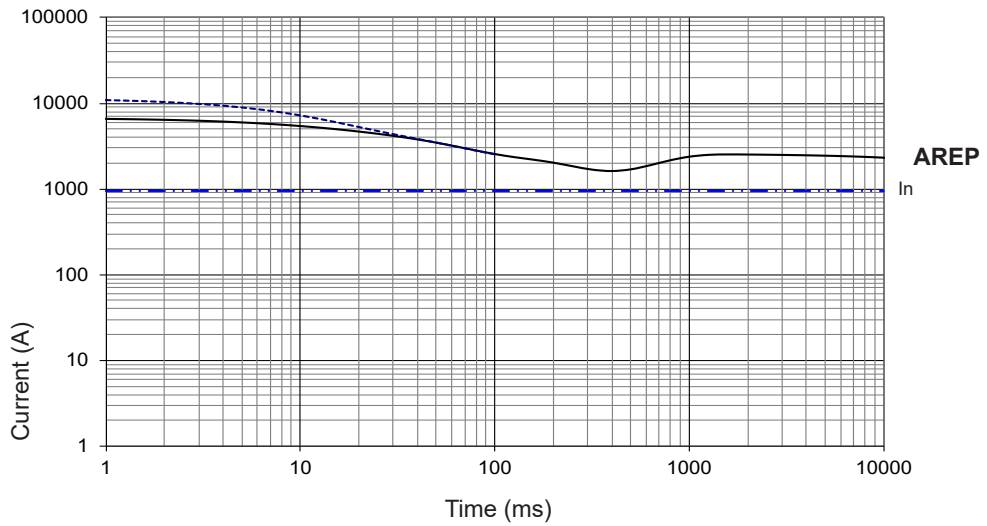

LSA 49.3 M6

Symmetrical —  
Asymmetrical - - -

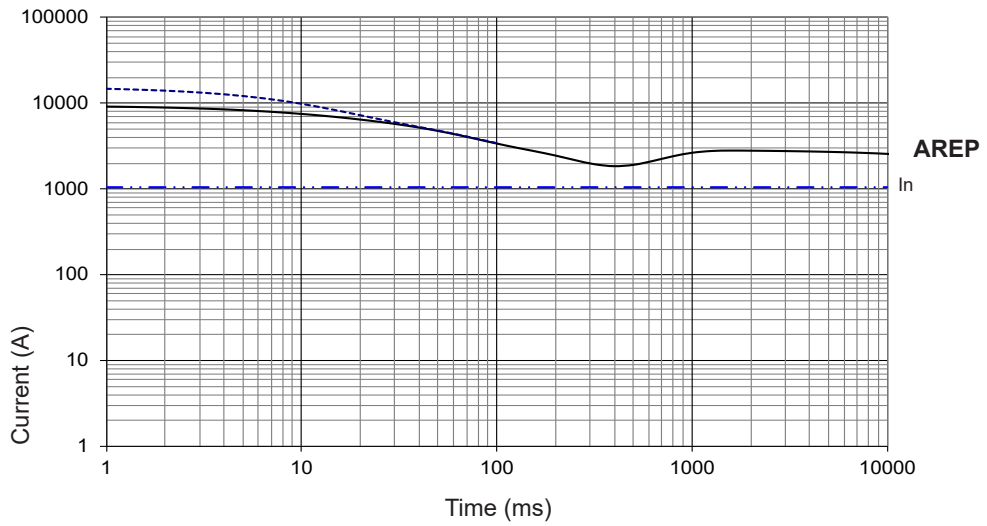

LSA 49.3 M8

Symmetrical —  
Asymmetrical - - -

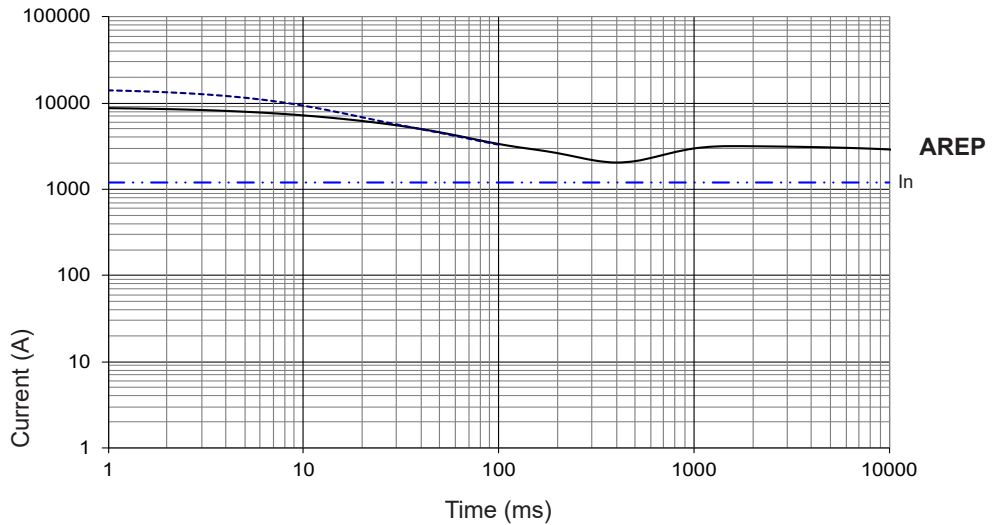

Influence due to connection

Curves shown are for star (Y) connection.

For other connections, use the following multiplication factors:

- Series delta : current value x 1.732 - Parallel star : current value x 2



3-phase short-circuit curves at no load and rated speed (star connection Y)

LSA 49.3 L9

Symmetrical —  
Asymmetrical - - -

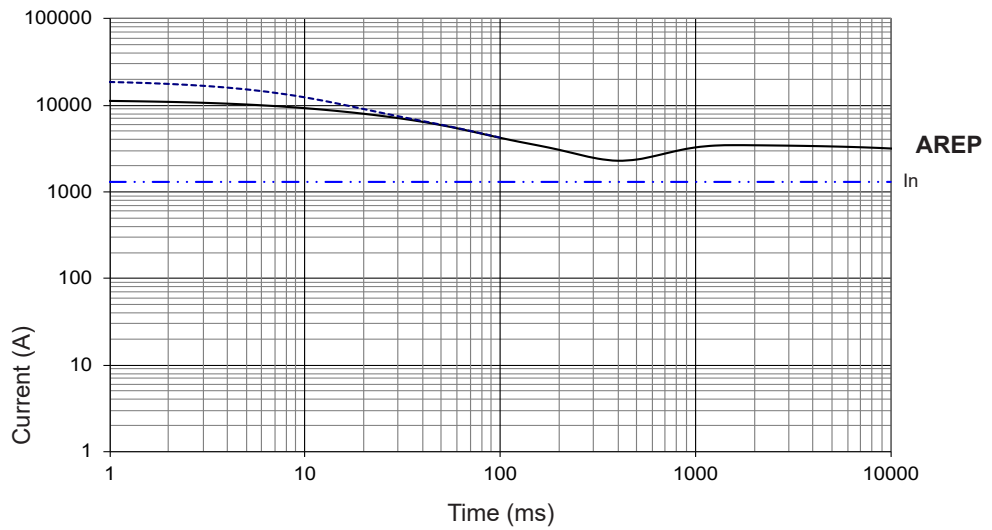

LSA 49.3 L10

Symmetrical —  
Asymmetrical - - -

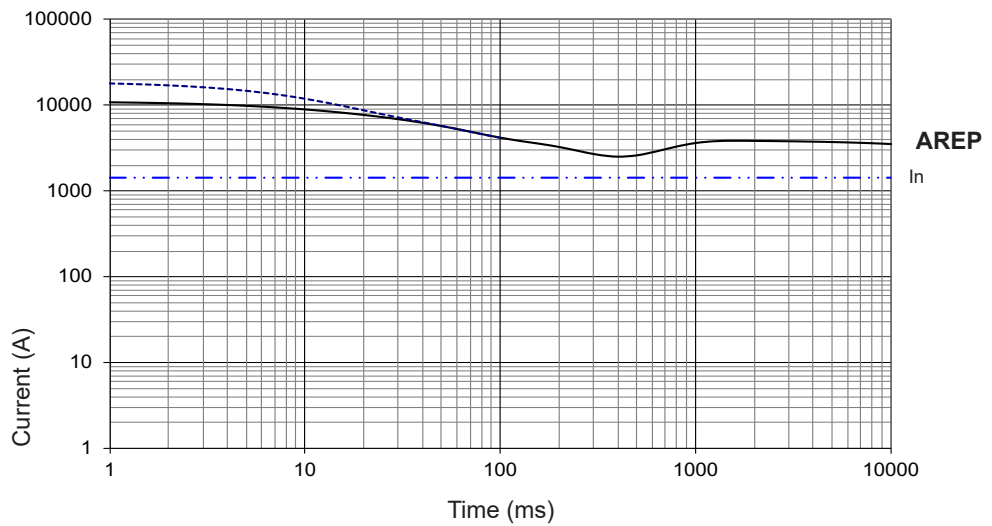

**Influence due to short-circuit**

Curves are based on a three-phase short-circuit.  
For other types of short-circuit, use the following multiplication factors.

	3-phase	2-phase L/L	1-phase L/N
Instantaneous (max.)	1	0.87	1.3
Continuous	1	1.5	2.2
Maximum duration (AREP/PMG)	10 sec.	5 sec.	2 sec.

Single-bearing dimensions

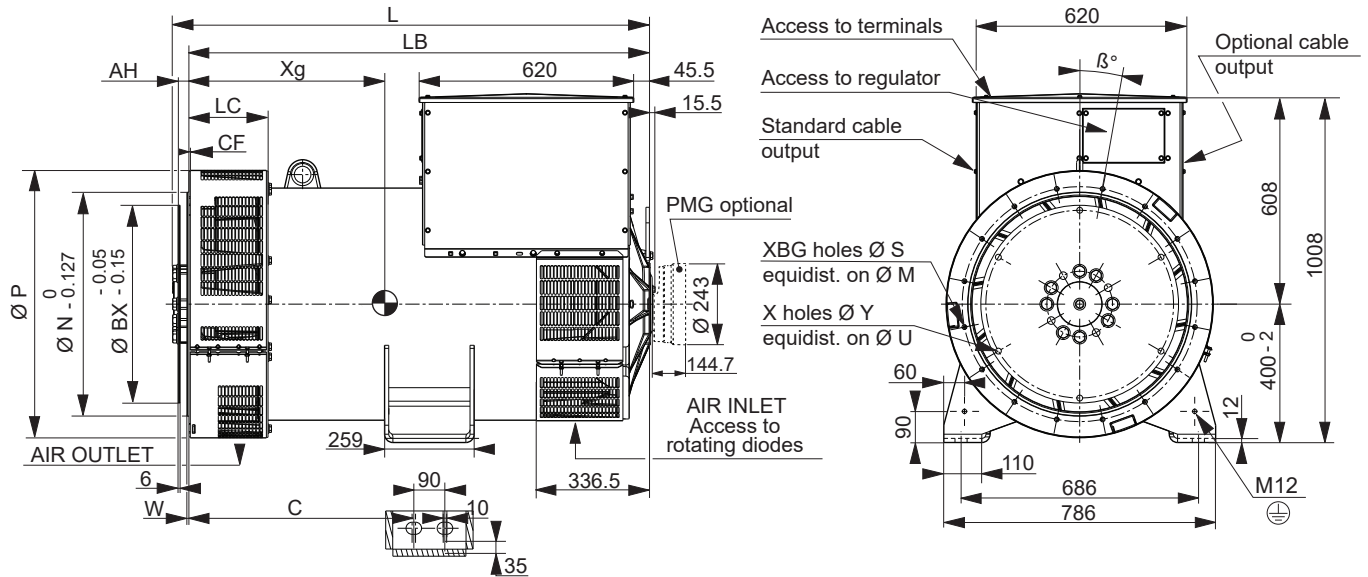

Dimensions (mm) and weight						Coupling		
Type	L without PMG maxi*	LB	C	Xg	Weight (kg)	Flex plate		
LSA 49.3 S4	1282	1241	560	590	1431	14	18	
LSA 49.3 M6	1372	1331	650	629	1578	X		
LSA 49.3 M8	1372	1331	650	636	1639	X		
LSA 49.3 L9	1462	1421	650	673	1792	X	X	
LSA 49.3 L10	1462	1421	650	681	1841			X

\* L maxi = LB + AH maxi + 15.5

Flange (mm)										Flex plate (mm)					
S.A.E.	P	N	M	LC	XBG	S	W	β°	CF	S.A.E.	BX	U	X	Y	AH
1	773	511.175	530.225	228.5	12	12	6	15°	38	14	466.7	438.15	8	14	25.4
1/2	773	584.2	619.125	228.5	12	14	6	15°	17	18	571.5	542.92	6	17	15.7
0	773	647.7	679.45	228.5	16	14	6	11° 15'	37						
00	883	787.4	850.9	245	16	14	7	11° 15'	40						

Torsional analysis data

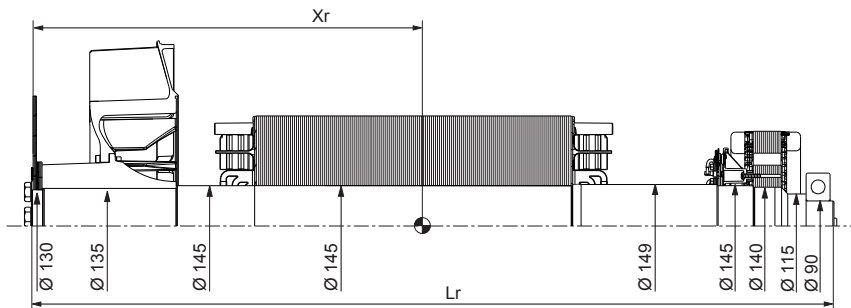

Centre of gravity: Xr (mm), Rotor length: Lr (mm), Weight: M (kg), Moment of inertia: J (kgm²): (4J = MD²)								
Flange	S.A.E. 14				S.A.E. 18			
	Xr	Lr	M	J	Xr	Lr	M	J
LSA 49.3 S4	584	1255	539	8.51	572	1255	541	8.77
LSA 49.3 M6	626	1345	602	9.61	614	1345	604	9.87
LSA 49.3 M8	634	1345	628	10.16	622	1345	630	10.42
LSA 49.3 L9	671	1435	684	11.12	659	1435	686	11.38
LSA 49.3 L10	681	1435	701	11.48	669	1435	703	11.74

NOTE : Dimensions are for information only and may be subject to modifications. Contractual 2D drawings can be downloaded from the Leroy-Somer site, 3D drawing files are available upon request. The torsional analysis of the transmission is imperative. All values are available upon request.

Two-bearing dimensions

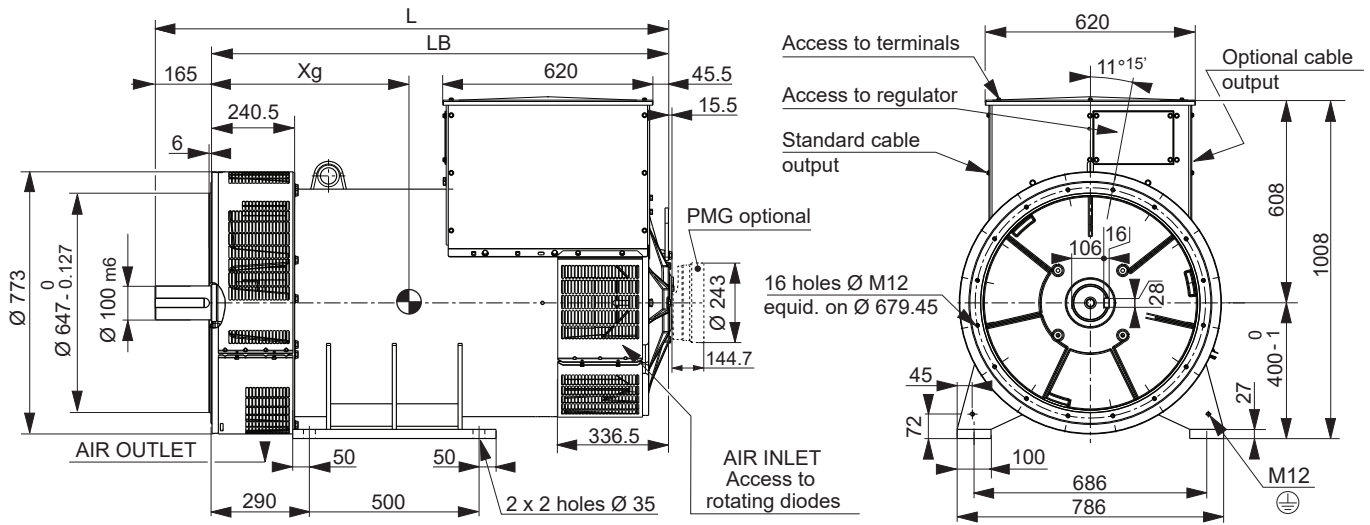

Dimensions (mm) and weight				
Type	L without PMG	LB	Xg	Weight (kg)
LSA 49.3 S4	1424	1259	596	1480
LSA 49.3 M6	1514	1349	636	1622
LSA 49.3 M8	1514	1349	643	1683
LSA 49.3 L9	1604	1439	682	1835
LSA 49.3 L10	1604	1439	688	1884

Torsional analysis data

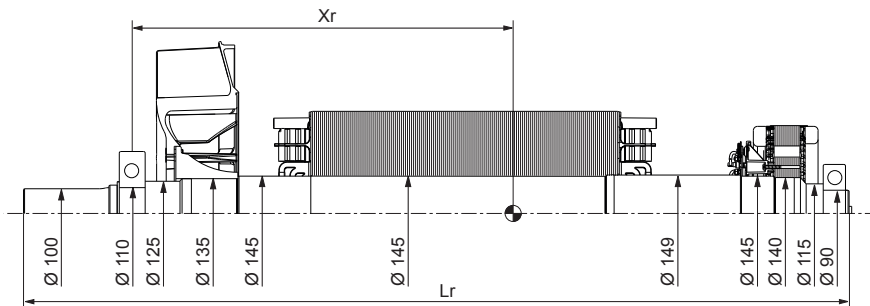

Centre of gravity: Xr (mm), Rotor length: Lr (mm), Weight: M (kg), Moment of inertia: J (kgm²): (4J = MD²)				
Type	Xr	Lr	M	J
LSA 49.3 S4	545	1409	512	8.07
LSA 49.3 M6	584	1499	574	9.18
LSA 49.3 M8	590	1499	600	9.73
LSA 49.3 L9	627	1589	656	10.69
LSA 49.3 L10	634	1589	673	11.05

**NOTE :** Dimensions are for information only and may be subject to modifications. Contractual 2D drawings can be downloaded from the Leroy-Somer site, 3D drawing files are available upon request. The torsional analysis of the transmission is imperative. All values are available upon request.

**LEROY-SOMER**<sup>™</sup>

[www.leroy-somer.com/epg](http://www.leroy-somer.com/epg)

Connect with us at:



***Nidec***  
All for dreams

© 2024 Moteurs Leroy-Somer SAS. The information contained in this brochure is for guidance only and does not form part of any contract. The accuracy cannot be guaranteed as Moteurs Leroy-Somer SAS have an ongoing process of development and reserve the right to change the specification of their products without notice.

Moteurs Leroy-Somer SAS. Headquarters: Bd Marcellin Leroy, CS 10015, 16915 Angoulême Cedex 9, France. Share Capital: 32,239,235 €, RCS Angoulême 338 567 258.