



Totally Focused. Totally Independent.

Technical Guide

RPa: ; ; P

C-TYPE



The world's largest
independent producer of
alternators 1 – 5,000kVA

Standards

Alternators are designed and produced within an ISO 9001 environment. The entire series is manufactured according to, and complies with, the most common specifications such as CEI 2-3, IEC 34-1, EN 60034-1, VDE 0530, BS 4999-5000, NF 51.111, NEMA MG 1-2011, ISO 8528-3. They also comply with other specific standards such as UL1446, UL 1004/4 and /B and CAN/CSA-C22.2 No14-95-No100-95.

Windings and Performances

All windings are 2/3rds pitch to eliminate triplen harmonics within the voltage waveform and to avoid excessive neutral currents in certain parallel operating conditions. A fully interconnected aluminium or copper damper cage is supplied on the rotor of all models (excluding the ECP3 series).

- ▶ 12 wire reconnectable:
50Hz – 380V to 440V and 220/110V to 240/120V (de-rates may apply at certain voltages)
60Hz – 380V to 480V and 220/110V to 240/120V (de-rates may apply at certain voltages)
- ▶ 6 wire reconnectable:
50Hz – 380V to 440V and 220V to 240V (de-rates may apply at certain voltages)
60Hz – 380V to 480V and 220V to 240V (de-rates may apply at certain voltages)

| Winding Configurations | Standard | | Special (dedicated) | | | |
|---------------------------------|---|-------------------------------|-------------------------------|-------------------------------|-------------------------------|-------------------------------|
| | 12 wire Reconnectable | 6 wire Reconnectable | 380V and 600V 60Hz | 690V 50/60Hz | 220-240V 1ph 50Hz | 220-240V 1ph 60Hz |
| ECP3 to ECO38 | Std | Option | Option | Option | Option | Option |
| ECO40 | Std | Option | Option | Option | Option (to ECO40) | Option (to ECO40) |
| Insulation materials | Class H | Class H | Class H | Class H | Class H | Class H |
| High efficiency | Std | Std | Std | Std | Std | Std |
| High motor starting | >300% | >300% | >300% | >300% | >300% | >300% |
| THD (Total Harmonic Distortion) | Typically <3.5% full load L-L | Typically <3.0% full load L-L | Typically <3.5% full load L-L | Typically <3.5% full load L-L | Typically <4.5% full load L-N | Typically <4.5% full load L-N |
| Interference suppression | VDE 0875 G/N/K, EN61000-6-3, EN61000-6-2, others available on request | | | | | |

Winding Protection

There are various degrees of protection for the windings following the standard impregnation process, as can be seen here. The TOTAL+ epoxy black coating is recommended for arduous applications.

| Winding Protection: | STANDARD | STANDARD+ | GREY | GREY+ | TOTAL+ |
|-----------------------|----------|-----------|--------|--------|--------|
| ECP3 | Std | Option | Option | Option | Option |
| ECP28 and ECP32 | - | Std | Option | Option | Option |
| NPE32, ECP34 to ECO40 | - | - | Std | Option | Option |

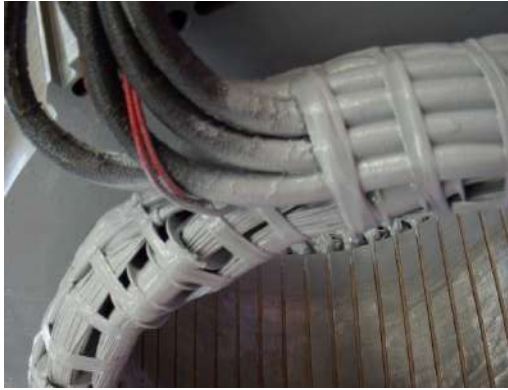

Grey treatment (marinization) on the left, TOTAL+ treatment shown on the right. The EG43 grey varnish, is a high temperature insulating enamel that forms a tough and flexible film, with excellent moisture and chemical protection. It is water and oil proof, and also protects windings from abrasion. It is applied spraying an over coating layer over the impregnated winding, or dipping the stator in a varnish barrel for superior treatments

The TOTAL+ is a protection system that makes Mecc Alte special. It is the ultimate winding treatment that offers truly superior performances when the environment is really harsh, or the application very demanding. The TOTAL+ is also extremely resistant to the particle abrasion as it adsorbs the impacts.

Protection for Environment

In addition to protection on the windings themselves, the alternators can have increased degree of protection. Standard level is IP23 but the following solutions are also available: IP23 DP with inlet filters, IP23 with only terminal box in IP45, IP43 and IP45. Derates may be applied.

Info: https://www.meccalte.com/downloads/MA0605_Bulletin_IP.pdf



Construction

The robust mechanical structure withstands up to 5G in any direction and 9G vertically and its design permits easy access to the connections and components during routine maintenance check-ups. The mechanical design has used the most advanced FEM techniques. The materials used are: FEP12 steel for the frame, C45 steel for the shaft and cast iron or aluminum pressure die cast for the end-brackets: fans are aluminum die casted either nylon fiber glass loaded, UL compliant materials. Rotors are dynamically balanced according grades 6.3 (up to series 32) or 2.5 (from series 34 onwards) of ISO 1940-1.

Terminals and Terminal Box

Easy access to regulators is possible due to a new AVR panel. Terminal boards have been redesigned into a special L configuration, specifically to ease customer connections; with this kind of terminal board it is possible to place a second terminal board in order to get 12 available terminals. Current transformers are available as an option on series ECO38 with single or dual output.

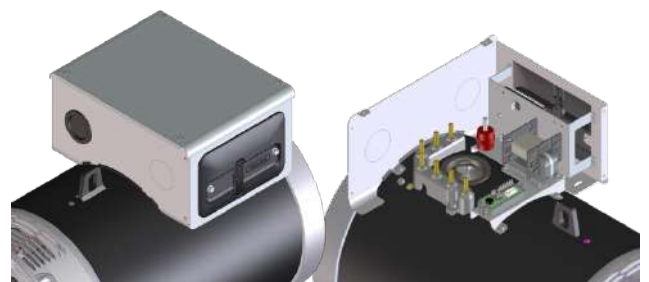

Excitation and Regulation Systems

All ECP/ECO series have MAUX auxiliary winding to power the digital regulator. Both DSR and the DER1 are available to connect to PC through the DxR2 USB interface and DxR TERMINAL software to interrogate/download alarms & settings for analysis or for cloning other regulators. DER2 has got an integrated USB connection and can be connected to the PC without any optional connection boards. More settings such as LAMS, digital RAM based synchronous external control and soft start are obtainable through the DxR connection. Simple analogue potentiometers are available for the more usual adjustments.

| Excitation Systems | DSR | DER1 | DER2 |
|--|-------|---------|---------|
| ECP3 to ECO38 | Std | Option | Option |
| ECO40 | - | Std | Option |
| Parallel Operation | √ | √ | √ |
| Mains Parallel | √ | √ | √ |
| 3 Phase Sensing (rms) | - | √ | √ |
| Accuracy | +/-1% | +/-0.5% | +/-0.5% |
| Remote Voltage Control | √ | √ | √ |
| Alarm Log | √ | √ | √ |
| Analogue and Digital Configurable | √ | √ | √ |
| LAMS (Load Acceptance V/f) | √ | √ | √ |
| APO (Active Protection Output) | √ | √ | √ |
| Soft Start | √ | √ | √ |
| High dynamic response | - | - | √ |
| USB connection without external boards | - | - | √ |

For a given motor start duty a smaller machine may be selected – also enhanced by low sub-transient reactance values for non-linear loads. The whole range is capable of >300% sustained short circuit current for up to 20 seconds.

Optional PMG

The Mecc Alte PMG is available on ECP28, ECP32, ECP34 and ECO38 as factory-fitted option; alternatively, only the predisposition for the retrofit, for subsequent assembly, is available on option. On series ECO40 is available as a factory-fitted or retro-fitted options.

The complete AVR range is fully compatible with both MAUX and PMG systems; this minimises spare parts management and flexibility of stock as one AVR suits all applications.

The PMG is delivering the same amount of kVA available with the MAUX.



Dew Heater

Our whole range can be fitted with anti-condensation heaters of adequate power sized to alternator kVA. Voltage for heaters must be specified when ordering. New cylindrical cartridge style heaters are available on request and it can be retrofitted.

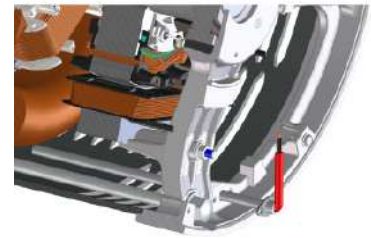

Accessories

Additional optionals can be fit on our alternator series, such as PTC thermistors or PT100 both on windings and bearings, dew heaters, high and low profile of terminal boxes (on most series), parallel devices (standard from ECO38), current and voltage transformers, air filters, IP43 and IP45 protections and many others.

For more info visit: <https://www.meccalte.com/en/products/alternators/accessories/c-type-accessories>

Deration coefficients

| Altitude (meters) | Ambient temperature (Celsius) | | | | | |
|--------------------|-------------------------------|------|------|------|------|------|
| | 25 | 40 | 45 | 50 | 55 | 60 |
| ≤ 1000 | 1.07 | 1 | 0.96 | 0.93 | 0.91 | 0.89 |
| $> 1000 \leq 1500$ | 1.01 | 0.96 | 0.92 | 0.89 | 0.87 | 0.84 |
| $> 1500 \leq 2000$ | 0.96 | 0.91 | 0.87 | 0.84 | 0.83 | 0.79 |
| $> 2000 \leq 3000$ | 0.9 | 0.85 | 0.81 | 0.78 | 0.76 | 0.73 |

Notes on short circuit curves

The indicated coefficients have to be used to correct the three phase short circuit curves values as a function of the rated voltage.

The indicated coefficient have to be used to correct the three phase short circuit curves values as a function of the type of short circuit voltage.

| 50 Hz | | 60 Hz | |
|---------|--------|---------|--------|
| Voltage | Factor | Voltage | Factor |
| 380 | 0.93X | 415 | 0.85X |
| 400 | 1X | 440 | 0.90X |
| 415 | 1.04X | 460 | 0.95X |
| 440 | 1.10X | 480 | 1X |

| | 3 phase | 2 phase L-L | 1 phase L-N |
|---------------------|---------|-------------|-------------|
| <i>Istantaneous</i> | 1X | 0.87X | 1.30X |
| <i>Minimum</i> | 1X | 1.80X | 3.20X |
| <i>Sustained</i> | 1X | 1.50X | 2.50X |
| <i>Max Duration</i> | 20 sec. | 10 sec. | 4 sec. |

All the curves are shown for series or parallel star connection at 400V 50 Hz or 480V 60 Hz. If the unit is reconnected from series to parallel star, the additional coefficient is 2X. From series star to series delta, it is 1.72X. From series star to parallel delta, it is 3.44X.

O

| | | | |
|---------------------|----------|----------------|---------------|
| a w tw | : | V s ° us | U |
| azs w tw | : | a wu ° us | U9: |
|] tw x ° w | 88 |] QR Dvs ° y w | @ 888c d |
| R wu ° | O z w | QR Dvs ° y w | @ 8 8c d |
| c w y s w | Qdc | [s ° ^ w w w | 99=7 |
| h ° v ° y ° uz | 96: | N ° v w | 7 48777 |
| P v w syw w w w w w | e7; 7=d: | Os s u° y | Vf ^ 8c; 7 48 |

NEp

| gN6 h Mew 5c ° w6N t°w P479a5 | | | | | | | | | | | | | | | | | | | | |
|-------------------------------|-------|------------|-------|-----------------|-------|------------|-------|-----------|-------|-------------|-------|-----------|-------|------------|-------|---------|-------|------------|-------|-------|
| deN] Q0k48@ 69A | | | | deN] Q0k48-7; 7 | | | | U487=6; 7 | | | | S487=6; 7 | | | | O487; 7 | | | | |
| dw°w d s k | : B7g | : 77g | : 8-g | :: 7g | : B7g | : 77g | : 8-g | :: 7g | : B7g | : 77g | : 8-g | :: 7g | : B7g | : 77g | : 8-g | :: 7g | : B7g | : 77g | : 8-g | :: 7g |
| as s w d s k k | 8C7g | 977g | 97Bg | 997g | 8C7g | 977g | 97Bg | 997g | 8C7g | 977g | 97Bg | 997g | 8C7g | 977g | 97Bg | 997g | 8C7g | 977g | 97Bg | 997g |
| dw°w Qw s Δ | 997g | 9: 7g | 9: 7g | 9=; g | 997g | 9: 7g | 9: 7g | 9=; g | 997g | 9: 7g | 9: 7g | 9=; g | 997g | 9: 7g | 9: 7g | 9=; g | 997g | 9: 7g | 9: 7g | 9=; g |
| as s w Qw s ΔΔ | 887g | 88-g | 887g | 88Ag | 887g | 88-g | 887g | 88Ag | 887g | 88-g | 887g | 88Ag | 887g | 88-g | 887g | 88Ag | 887g | 88-g | 887g | 88Ag |
| VR S k | 96 | 96 | 96 | 79 | 93 | 93 | 93 | 77 | 87,5 | 87,5 | 87,5 | 72 | 79 | 79 | 79 | 65 | 70 | 70 | 70 | 58 |
| | 77 | 77 | 77 | 63 | 74 | 74 | 74 | 62 | 70 | 70 | 70 | 58 | 63 | 63 | 63 | 52 | 56 | 56 | 56 | 46 |
| VR V k | 110 | 110 | 110 | 88 | 105 | 105 | 105 | 86 | 100 | 100 | 100 | 80 | 90 | 90 | 90 | 72 | 80 | 80 | 80 | 64 |
| | 88 | 88 | 88 | 70 | 84 | 84 | 84 | 69 | 80 | 80 | 80 | 64 | 72 | 72 | 72 | 58 | 64 | 64 | 64 | 51 |
| VR S k | 137 | 137 | 137 | 117 | 132 | 132 | 132 | 112 | 125 | 125 | 125 | 106 | 112 | 112 | 112 | 96 | 100 | 100 | 100 | 85 |
| | 110 | 110 | 110 | 94 | 106 | 106 | 106 | 90 | 100 | 100 | 100 | 85 | 90 | 90 | 90 | 77 | 80 | 80 | 80 | 68 |
| VR V k | 148 | 148 | 148 | 125 | 143 | 143 | 143 | 120 | 135 | 135 | 135 | 114 | 121 | 121 | 121 | 103 | 108 | 108 | 108 | 91 |
| | 118 | 118 | 118 | 100 | 114 | 114 | 114 | 96 | 108 | 108 | 108 | 91 | 97 | 97 | 97 | 82 | 86 | 86 | 86 | 73 |
| VR S k | 165 | 165 | 165 | 137 | 158 | 158 | 158 | 131 | 150 | 150 | 150 | 125 | 136 | 136 | 136 | 113 | 120 | 120 | 120 | 100 |
| | 132 | 132 | 132 | 110 | 126 | 126 | 126 | 105 | 120 | 120 | 120 | 100 | 109 | 109 | 109 | 90 | 96 | 96 | 96 | 80 |
| VR V k | 176 | 181 | 181 | 170 | 169 | 174 | 174 | 163 | 160 | 165 | 165 | 155 | 144 | 149 | 149 | 139 | 128 | 132 | 132 | 124 |
| | 141 | 145 | 145 | 136 | 135 | 139 | 139 | 130 | 128 | 132 | 132 | 124 | 115 | 119 | 119 | 111 | 102 | 106 | 106 | 99 |

PEp

| gN6 h Mew 5c ° w6N t°w P479a5 | | | | | | | | | | | | | | | | | | | | |
|-------------------------------|-------|-------|-------|-----------------|-------|-------|-------|------------|-------|-------|-------|------------|-------|-------|-------|------------|-------|-------|-------|------------|
| deN] Q0k48@ 69A | | | | deN] Q0k48-7; 7 | | | | U487=6; 7 | | | | S487=6; 7 | | | | O487; 7 | | | | |
| dw°w d s k | : 8-g | : 7g | @g | : B7g | : 8-g | : 7g | @g | : B7g | : 8-g | : 7g | @g | : B7g | : 8-g | : 7g | @g | : B7g | : 8-g | : 7g | @g | : B7g |
| as s w d s k k | 97Bg | 997g | 9: 7g | 9: 7g | 97Bg | 997g | 9: 7g | 9: 7g | 97Bg | 997g | 9: 7g | 9: 7g | 97Bg | 997g | 9: 7g | 9: 7g | 97Bg | 997g | 9: 7g | 9: 7g |
| dw°w Qw s Δ | 9: 7g | 9=; g | 9@-g | 9AAg | 9: 7g | 9=; g | 9@-g | 9AAg | 9: 7g | 9=; g | 9@-g | 9AAg | 9: 7g | 9=; g | 9@-g | 9AAg | 9: 7g | 9=; g | 9@-g | 9AAg |
| as s w Qw s ΔΔ | 887g | 88Ag | 8: g | 8 Bg | 887g | 88Ag | 8: g | 8 Bg | 887g | 88Ag | 8: g | 8 Bg | 887g | 88Ag | 8: g | 8 Bg | 887g | 88Ag | 8: g | 8 Bg |
| VR S k | 108 | 115 | 115 | 115 | 104 | 111 | 111 | 111 | 98 | 105 | 105 | 105 | 88 | 95 | 95 | 95 | 78 | 84 | 84 | 84 |
| | 86 | 92 | 92 | 92 | 83 | 89 | 89 | 89 | 78 | 84 | 84 | 84 | 70 | 76 | 76 | 76 | 62 | 67 | 67 | 67 |
| VR V k | 120 | 132 | 132 | 132 | 114 | 126 | 126 | 126 | 110 | 120 | 120 | 120 | 99 | 109 | 109 | 109 | 88 | 96 | 96 | 96 |
| | 96 | 106 | 106 | 106 | 91 | 101 | 101 | 101 | 88 | 96 | 96 | 96 | 79 | 87 | 87 | 87 | 70 | 77 | 77 | 77 |
| VR S k | 143 | 154 | 165 | 165 | 137 | 147 | 159 | 159 | 130 | 140 | 150 | 150 | 116 | 125 | 135 | 135 | 104 | 112 | 120 | 120 |
| | 114 | 123 | 132 | 132 | 110 | 118 | 127 | 127 | 104 | 112 | 120 | 120 | 93 | 100 | 108 | 108 | 83 | 90 | 96 | 96 |
| VR V k | 154 | 165 | 178 | 178 | 148 | 159 | 172 | 172 | 140 | 150 | 162 | 162 | 125 | 135 | 146 | 146 | 112 | 120 | 130 | 130 |
| | 123 | 132 | 142 | 142 | 118 | 127 | 138 | 138 | 112 | 120 | 130 | 130 | 100 | 108 | 117 | 117 | 90 | 96 | 104 | 104 |
| VR S k | 165 | 187 | 198 | 198 | 158 | 178 | 189 | 189 | 150 | 170 | 180 | 180 | 132 | 150 | 163 | 163 | 120 | 136 | 144 | 144 |
| | 132 | 150 | 158 | 158 | 126 | 142 | 151 | 151 | 120 | 136 | 144 | 144 | 106 | 120 | 130 | 130 | 96 | 109 | 115 | 115 |
| VR V k | 187 | 210 | 218 | 218 | 179 | 201 | 208 | 208 | 170 | 191 | 198 | 198 | 155 | 165 | 178 | 178 | 136 | 153 | 158 | 158 |
| | 150 | 168 | 174 | 174 | 143 | 161 | 166 | 166 | 136 | 153 | 158 | 158 | 124 | 132 | 142 | 142 | 109 | 122 | 126 | 126 |

2 Ai p DME

| f s s vw / wSR] @7.; 4 0 | RPa.; 8d; P | RPa.; 9d; P | RPa.; 8; P | RPa.; 9[; P | RPa.; 8Z; P | RPa.; 9Z; P |
|--|-------------|-------------|------------|-------------|-------------|-------------|
| Xd Q° wu 4s ° uz w6u s uw % | 324 | 241,2 | 281,3 | 327,6 | 225,3 | 220,4 |
| X'd Q° wu 4s ° s 'w w6u s uw % | 22,3 | 18,4 | 21,5 | 22,8 | 13,9 | 18,2 |
| X''d Q° wu 4s ° t s 'w w6u s uw % | 7,4 | 6 | 7 | 11,1 | 5,8 | 7,7 |
| Xq b sv s w4s ° uz w6u s uw % | 170,2 | 157 | 183,2 | 200,9 | 114,8 | 150,3 |
| X'q b sv s w4s ° s 'w w6u s uw % | 170,2 | 157 | 183,2 | 200,9 | 114,8 | 150,3 |
| X''q b sv s w4s ° t s 'w w6u s uw % | 29,5 | 32,7 | 38,2 | 41,5 | 24,9 | 32,6 |
| X2] wps ° w4 w w uw w6u s uw % | 17,8 | 18,8 | 22 | 25,7 | 14,8 | 19,5 |
| Xo l w w w uw w6u s uw % | 3,59 | 3,67 | 4,29 | 3,97 | 2,35 | 3,12 |
| ds s vw | | | | | | |
| Xd Q° wu 4s ° uz w6u s uw % | 275,4 | 205 | 239,1 | 278,5 | 191,5 | 187,3 |
| X'd Q° wu 4s ° s 'w w6u s uw % | 19 | 15,6 | 18,3 | 19,4 | 11,8 | 15,5 |
| X''d Q° wu 4s ° t s 'w w6u s uw % | 6,29 | 5,1 | 5,95 | 9,43 | 4,93 | 6,54 |
| Xq b sv s w4s ° uz w6u s uw % | 144,7 | 133,4 | 155,7 | 170,8 | 97,6 | 127,8 |
| X'q b sv s w4s ° s 'w w6u s uw % | 144,7 | 133,4 | 155,7 | 170,8 | 97,6 | 127,8 |
| X''q b sv s w4s ° t s 'w w6u s uw % | 25,1 | 27,8 | 32,5 | 35,3 | 21,2 | 27,7 |
| X2] wps ° w4 w w uw w6u s uw % | 15,1 | 16 | 18,7 | 21,8 | 12,6 | 16,6 |
| Xo l w w w uw w6u s uw % | 3,59 | 3,67 | 4,29 | 3,97 | 2,35 | 3,12 |
| Kcc dz l' u ° s ° | 0,36 | 0,49 | 0,42 | 0,36 | 0,52 | 0,53 |
| T'd e s 'w ° wu s sec | 0,056 | 0,059 | 0,069 | 0,085 | 0,053 | 0,073 |
| T''d d t s 'w ° wu s sec | 0,012 | 0,014 | 0,017 | 0,019 | 0,011 | 0,014 |
| T'do ^ w l' u ° ° wu s sec | 0,82 | 0,77 | 0,9 | 1,22 | 0,86 | 0,88 |
| Ta N s w ° wu s sec | 0,016 | 0,018 | 0,021 | 0,026 | 0,017 | 0,02 |

g Ai p DME

| | | | | | | |
|-------------------------------------|-----------|-----------|---------|---------|-----------|-----------|
| lo R l' s ° u w s sv A | 0,7 | 0,5 | 0,6 | 0,5 | 0,7 | 0,6 |
| lc R l' s ° u w s x sv A | 2,7 | 2,4 | 2,7 | 2,6 | 2,9 | 2,8 |
| ^ w sv 8z ° s @z w ° v 887, s vw sv | | | | | | |
| ^ w sv w 97 w6s 300 | | | | | | |
| Uw6 v ° s ° W | 5922 | 6957 | 8342 | 8254 | 8755 | 10088 |
| eww z wUs 'u Ssu 4eUS % | <2 | <2 | <2 | <2 | <2 | <2 |
| h s wx Q° 5eUQ0x sv ZZ6Z % | 2,3 / 2,3 | 2,2 / 2,3 | 2 / 2,2 | 1,8 / 2 | 1,8 / 1,9 | 1,9 / 2 |
| h s wx Q° 5eUQ0 sv ZZ6Z % | 2,5 / 2,9 | 2,9 / 3 | 2,8 / 3 | 2,7 / 3 | 2,7 / 2,9 | 2,7 / 2,9 |

2 Ai p DMRE

| f s s vw / wSR] @7.; 4 0 | RPa.; 8d; P | RPa.; 9d; P | RPa.; 8; P | RPa.; 9[; P | RPa.; 8Z; P | RPa.; 9Z; P |
|--|-------------|-------------|------------|-------------|-------------|-------------|
| Xd Q° wu 4s ° uz v6u s uw % | 324 | 241,2 | 281,3 | 327,6 | 225,3 | 227,3 |
| X'd Q° wu 4s ° s 'w v6u s uw % | 22,3 | 18,4 | 21,5 | 22,8 | 13,9 | 18,8 |
| X''d Q° wu 4s ° t s 'w v6u s uw % | 7,4 | 6 | 7 | 11,1 | 5,8 | 7,94 |
| Xq b sv s w4s ° uz v6u s uw % | 170,2 | 157 | 183,2 | 200,9 | 114,8 | 155 |
| X'q b sv s w4s ° s 'w v6u s uw % | 170,2 | 157 | 183,2 | 200,9 | 114,8 | 155 |
| X''q b sv s w4s ° t s 'w v6u s uw % | 29,5 | 32,7 | 38,2 | 41,5 | 24,9 | 33,6 |
| X2] wps ° w4 w w uw v6u s uw % | 17,8 | 18,8 | 22 | 25,7 | 14,8 | 20,1 |
| Xo l w w w uw v6u s uw % | 3,59 | 3,67 | 4,29 | 3,97 | 2,35 | 3,22 |
| ds s vw | | | | | | |
| Xd Q° wu 4s ° uz v6u s uw % | 275,4 | 205 | 239,1 | 278,5 | 191,5 | 193,2 |
| X'd Q° wu 4s ° s 'w v6u s uw % | 19 | 15,6 | 18,3 | 19,4 | 11,8 | 16 |
| X''d Q° wu 4s ° t s 'w v6u s uw % | 6,29 | 5,1 | 5,95 | 9,43 | 4,93 | 6,75 |
| Xq b sv s w4s ° uz v6u s uw % | 144,7 | 133,4 | 155,7 | 170,8 | 97,6 | 131,8 |
| X'q b sv s w4s ° s 'w v6u s uw % | 144,7 | 133,4 | 155,7 | 170,8 | 97,6 | 131,8 |
| X''q b sv s w4s ° t s 'w v6u s uw % | 25,1 | 27,8 | 32,5 | 35,3 | 21,2 | 28,6 |
| X2] wps ° w4 w w uw v6u s uw % | 15,1 | 16 | 18,7 | 21,8 | 12,6 | 17,1 |
| Xo l w w w uw v6u s uw % | 3,59 | 3,67 | 4,29 | 3,97 | 2,35 | 3,22 |
| Kcc dz l' u ° s ° | 0,36 | 0,49 | 0,42 | 0,36 | 0,52 | 0,52 |
| T'd e s 'w ° wu s sec | 0,056 | 0,059 | 0,069 | 0,085 | 0,053 | 0,073 |
| T''d d t s 'w ° wu s sec | 0,012 | 0,014 | 0,017 | 0,019 | 0,011 | 0,014 |
| T'do ^ w l' u ° ° wu s sec | 0,82 | 0,77 | 0,9 | 1,22 | 0,86 | 0,88 |
| Ta N s w ° wu s sec | 0,016 | 0,018 | 0,021 | 0,026 | 0,017 | 0,02 |

g Ai p DMRE

| | | | | | | |
|-------------------------------------|-----------|-----------|---------|---------|-----------|-----------|
| lo R l' s ° u w s sv A | 0,7 | 0,5 | 0,6 | 0,5 | 0,7 | 0,6 |
| lc R l' s ° u w s x sv A | 2,7 | 2,4 | 2,7 | 2,6 | 2,9 | 2,8 |
| ^ w sv 8z ° s @z w ° v 887, s vw sv | | | | | | |
| ^ w sv w 97 w4s 300 | | | | | | |
| Uw6 v ° s ° W | 7603 | 8121 | 9730 | 9905 | 9846 | 10111 |
| eww z wV wxvs uwSsu 4eV5 | <40 | <40 | <40 | <40 | <40 | <40 |
| h s wx Q° 5eUQ0x sv ZZ6Z] % | 2,3 / 2,3 | 2,2 / 2,3 | 2 / 2,2 | 1,8 / 2 | 1,8 / 1,9 | 1,9 / 2 |
| h s wx Q° 5eUQ0 sv ZZ6Z] % | 2,5 / 2,9 | 2,9 / 3 | 2,8 / 3 | 2,7 / 3 | 2,7 / 2,9 | 2,7 / 2,9 |

m f NEp

| [vw | : 87g =7U | | | | | : 77g =7U | | | | | : 8-g =7U | | | | | : ; 7g =7U | | | | | |
|---------------|-----------|------|------|------|------|-----------|------|------|------|------|-----------|------|------|------|------|------------|------|------|------|------|------|
| | 79= | 75= | 75A= | 8 | 88 | 79= | 75= | 75A= | 8 | 88 | 79= | 75= | 75A= | 8 | 88 | 79= | 75= | 75A= | 8 | 88 | |
| RPa: ; 8i; P | % | 90,1 | 92,2 | 92,5 | 92,3 | 92,1 | 89,8 | 92,2 | 92,6 | 92,2 | 91,9 | 89,6 | 92,2 | 92,6 | 92,0 | 91,7 | 89,5 | 91,9 | 92,1 | 91,6 | 91,3 |
| RPa: ; 9d; P | % | 91,1 | 92,6 | 92,5 | 92,1 | 91,9 | 90,8 | 92,6 | 92,6 | 92,0 | 91,7 | 90,6 | 92,6 | 92,6 | 91,8 | 91,4 | 90,5 | 92,3 | 92,1 | 91,4 | 91,1 |
| RPa: ; 8; P | % | 91,2 | 93,0 | 92,8 | 92,2 | 92,0 | 91,3 | 93,2 | 93,1 | 92,3 | 92,0 | 91,1 | 93,1 | 92,9 | 92,0 | 91,7 | 90,8 | 92,8 | 92,4 | 91,5 | 91,2 |
| RPa: ; 9[; P | % | 91,9 | 93,3 | 93,2 | 92,8 | 92,5 | 92,0 | 93,5 | 93,5 | 92,9 | 92,5 | 91,8 | 93,4 | 93,3 | 92,6 | 92,2 | 91,7 | 93,2 | 92,9 | 92,2 | 91,8 |
| RPa: ; 8Z; P | % | 93,0 | 93,5 | 93,5 | 93,1 | 92,8 | 92,9 | 93,7 | 93,7 | 93,2 | 92,9 | 92,5 | 93,5 | 93,5 | 92,8 | 92,5 | 92,5 | 93,3 | 93,1 | 92,5 | 92,2 |
| RPa: ; 9Z; P | % | 93,9 | 94,1 | 93,5 | 92,9 | 92,5 | 93,6 | 94,1 | 93,6 | 92,9 | 92,5 | 93,4 | 94,1 | 93,5 | 92,6 | 92,2 | 93,3 | 93,8 | 93,1 | 92,3 | 91,9 |

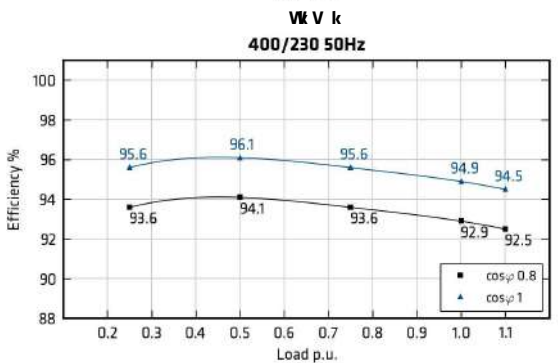
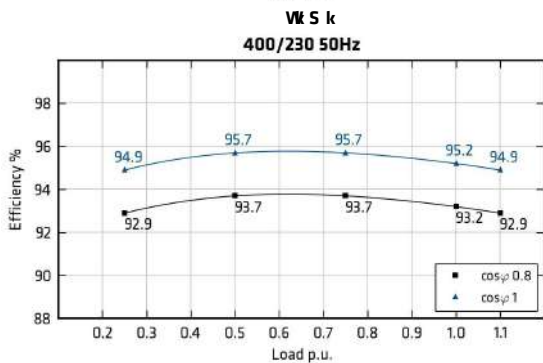
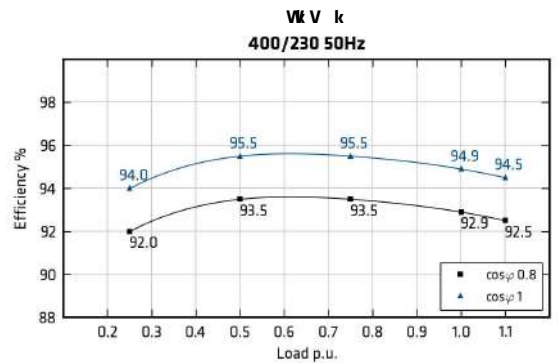
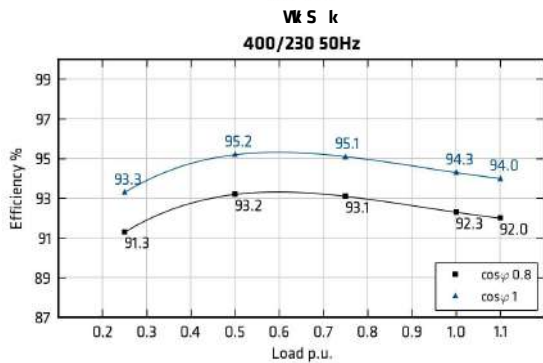
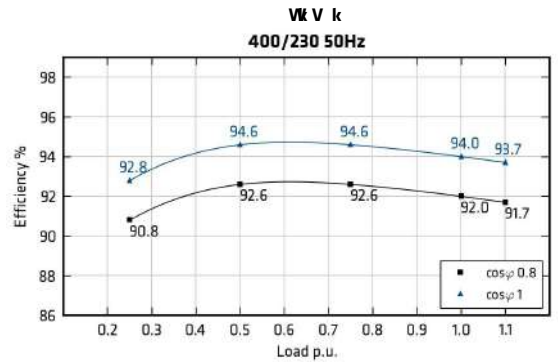
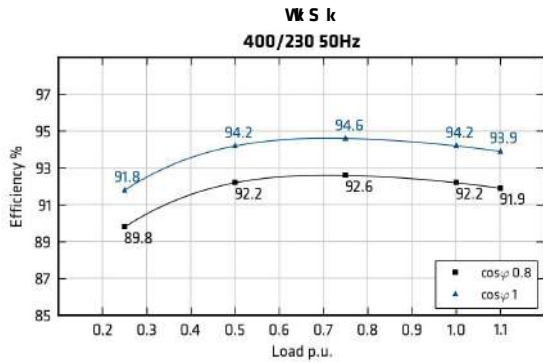

m f PEP

| [vw | ; 8-g @U | | | | | ; 7g @U | | | | | ; @g @U | | | | | ; 87g @U | | | | | |
|--------------|----------|------|------|------|------|---------|------|------|------|------|---------|------|------|------|------|----------|------|------|------|------|------|
| | 79= | 75= | 75A= | 8 | 88 | 79= | 75= | 75A= | 8 | 88 | 79= | 75= | 75A= | 8 | 88 | 79= | 75= | 75A= | 8 | 88 | |
| RPa: ; 8i; P | % | 91,6 | 93,2 | 92,8 | 91,1 | 90,3 | 91,6 | 93,3 | 92,9 | 91,5 | 91,0 | 91,6 | 93,4 | 93,2 | 91,8 | 91,3 | 93,4 | 93,2 | 91,7 | 91,1 | 91,1 |
| RPa: ; 9d; P | % | 92,1 | 93,7 | 93,1 | 91,6 | 90,6 | 92,1 | 93,8 | 93,2 | 92,1 | 91,4 | 92,1 | 93,9 | 93,5 | 92,3 | 91,5 | 91,8 | 93,9 | 93,5 | 92,2 | 91,5 |
| RPa: ; 8f; P | % | 92,5 | 94,0 | 93,3 | 91,7 | 91,0 | 92,6 | 94,2 | 93,7 | 92,1 | 91,2 | 92,6 | 94,3 | 94,0 | 92,4 | 91,7 | 92,5 | 94,5 | 94,1 | 92,5 | 91,8 |
| RPa: ; 9l; P | % | 92,9 | 94,4 | 93,6 | 92,0 | 91,3 | 93,1 | 94,7 | 94,1 | 92,5 | 91,8 | 93,1 | 94,8 | 94,4 | 92,8 | 92,0 | 93,0 | 95,0 | 94,5 | 92,9 | 92,2 |
| RPa: ; 8z; P | % | 94,0 | 95,0 | 94,1 | 92,9 | 92,5 | 94,0 | 95,1 | 94,4 | 93,3 | 92,9 | 93,9 | 95,1 | 94,4 | 93,5 | 93,1 | 93,8 | 95,3 | 94,6 | 93,6 | 93,2 |
| RPa: ; 9z; P | % | 95,2 | 95,5 | 94,6 | 93,4 | 92,8 | 95,2 | 95,6 | 94,8 | 93,8 | 93,3 | 95,2 | 95,7 | 94,9 | 94,0 | 93,4 | 94,9 | 95,7 | 95,0 | 94,0 | 93,5 |

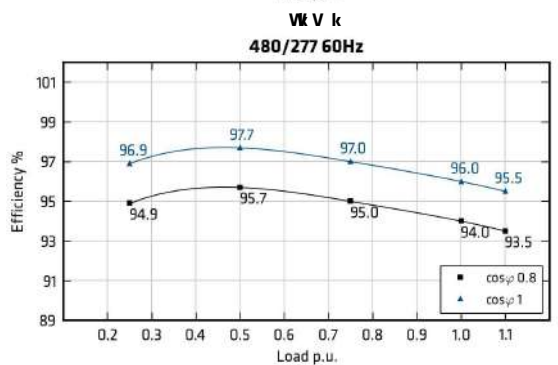
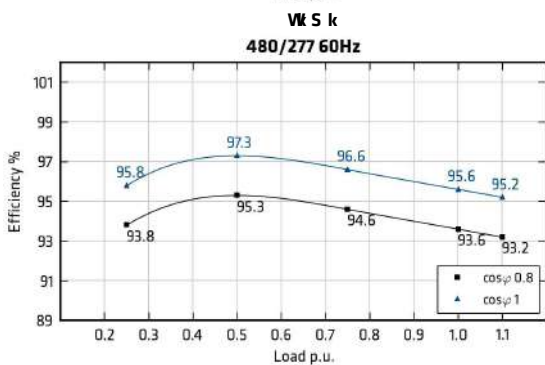
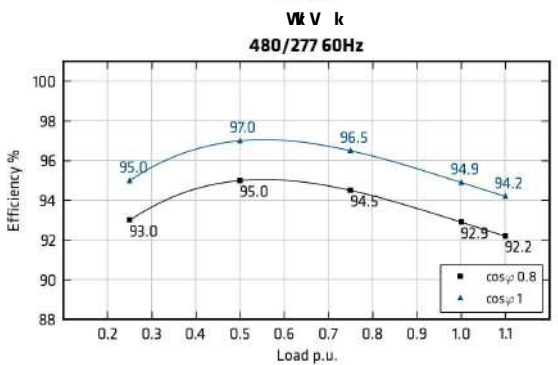
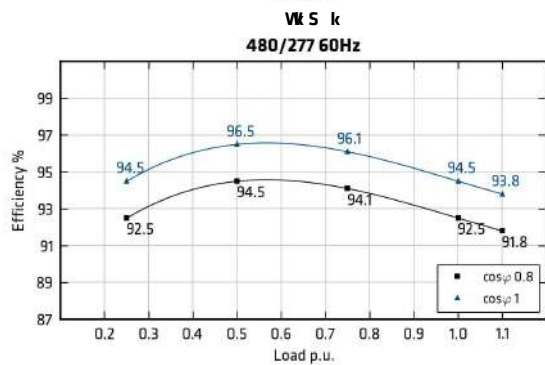
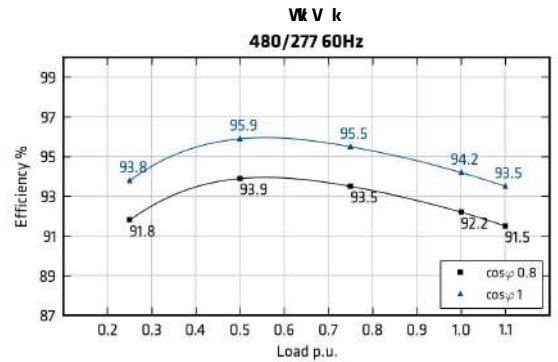
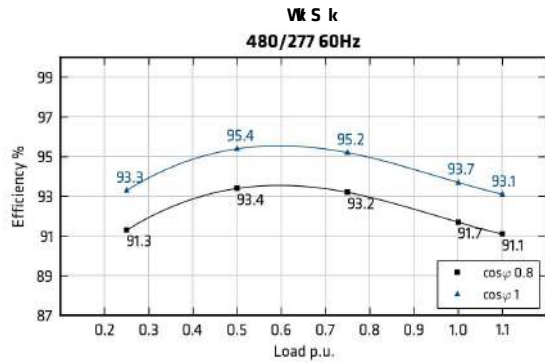

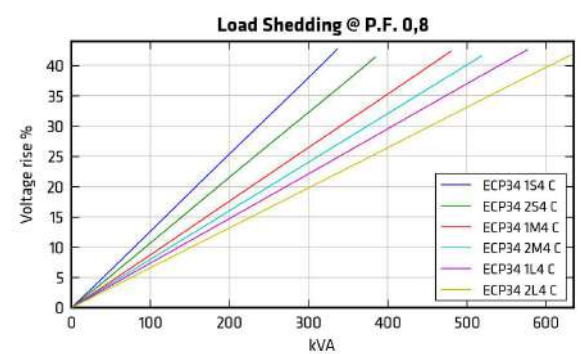
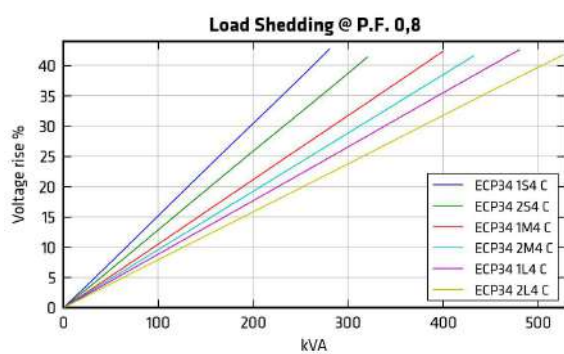
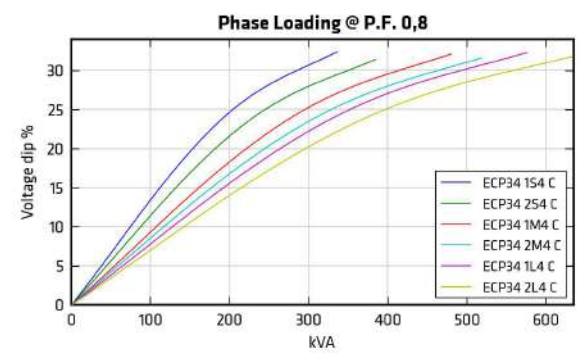
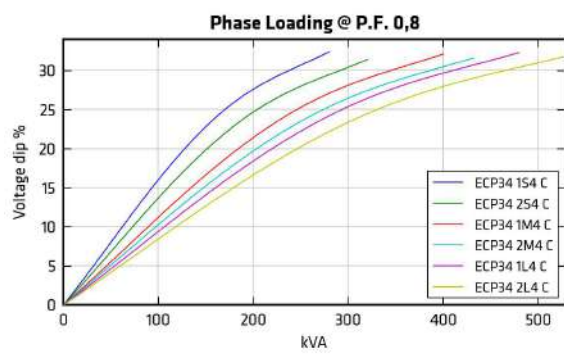
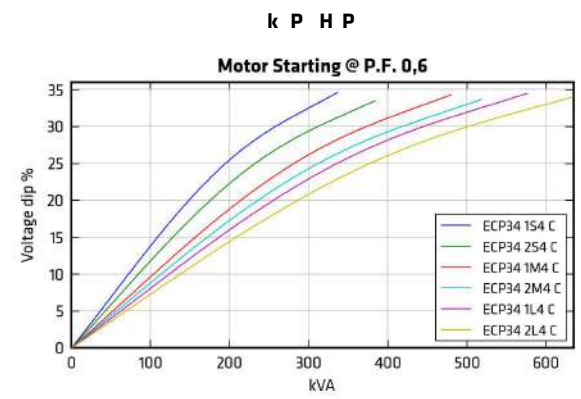
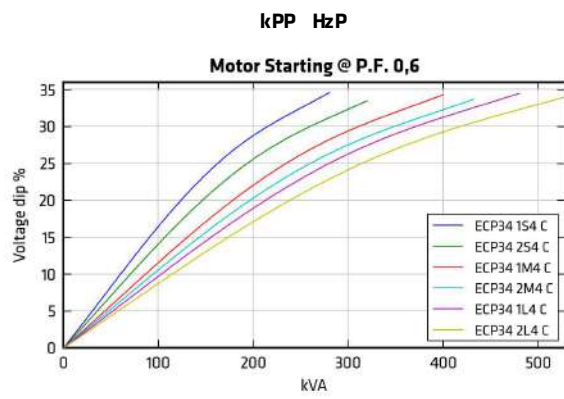

V vw usws w u w s s x u° xs w xsu syw° v'us w3 w6 w uww s x D

a w Ssu u w w u w u /aSPPB tw w w xsu 75@u w D

aSPPH° /Nc Pu /aS w 0679B

R s v6ezwaSPPs w xsu 75° 88C9 maSPPH° /Nc Pu /75 0679B 6ez° w6 z s zw sywxs s sy° w w s x75° w° s w zw

w z s us tw wsv zw x75@u w° x zw sv° u vww 88C9° w t'yyw /8C, z'yzw s v605

V z° w s v8s 87 gN sv° w° s x75° w° s w° sywxs s 88C gN sv° w° s x75@5

g sywu w w u w /g PPD

gPPH/;776g w 0° x=7 U EgPPH/; B76g w 0° x@ U

R s v6gPPs ;8-g @ U° 88:B ngPPH/; B76; 8-q96ez° w6 z s zw sywxs s sy° w w s ;8-g° w° s w zw w z s us tw wsv

zw w xsu 75@u w° x zw sv° u vww 88:B° w t'yyw /:; z'yzw s v605

V z° w s v8s 87 gN sv° w° s ;8-g° w° s w° sywxs s 8: gN sv° w° s ;B7g5

NEp

Ax

RPa: ; 8d; P

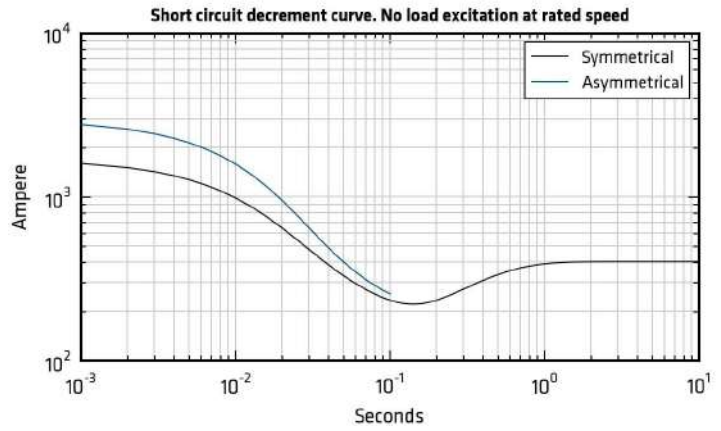

RPa: ; 9d; P

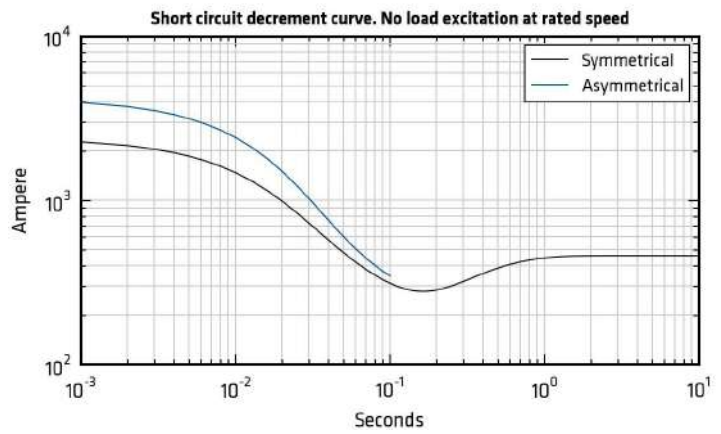

RPa: ; 8[; P

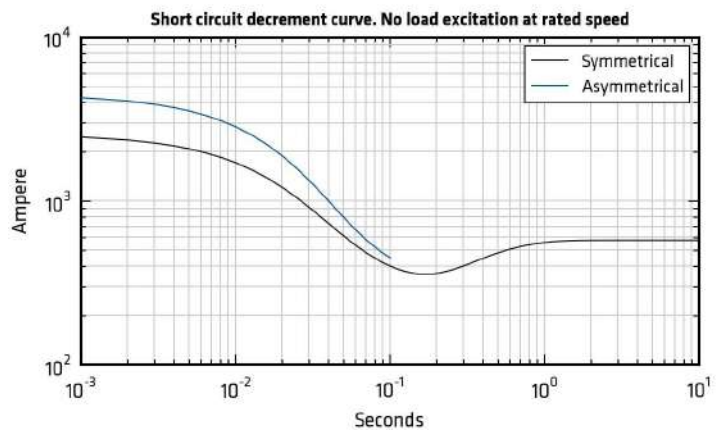

RPa: ; 9[; P

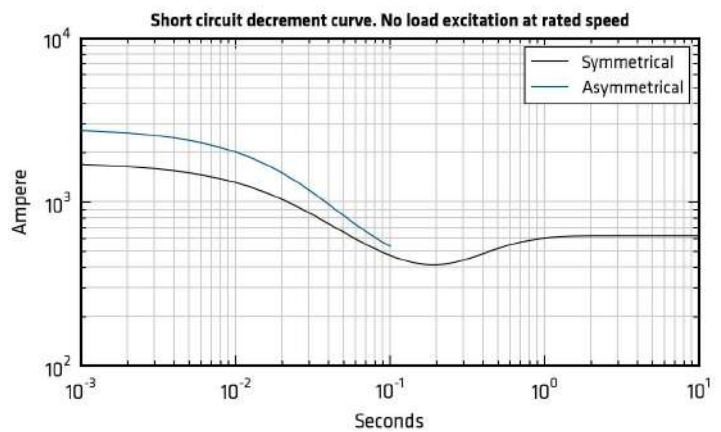

NEp

Ax

RPa: ; 8Z; P

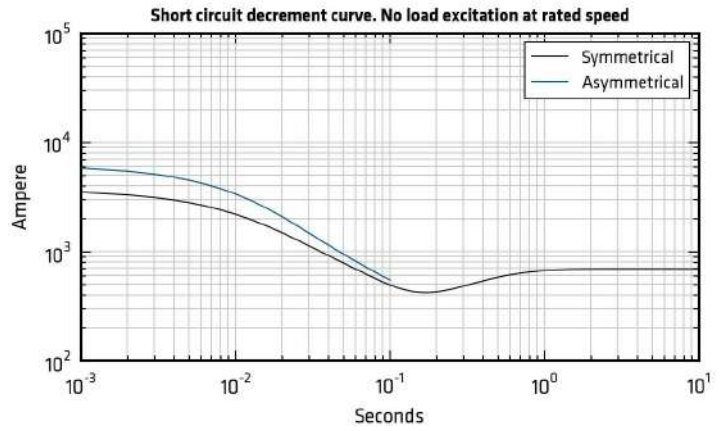

RPa: ; 9Z; P

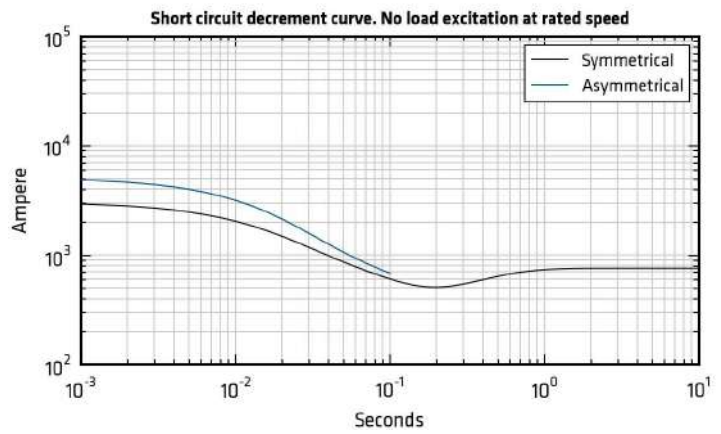

PEp

Ax

RPa: ; 8d; P

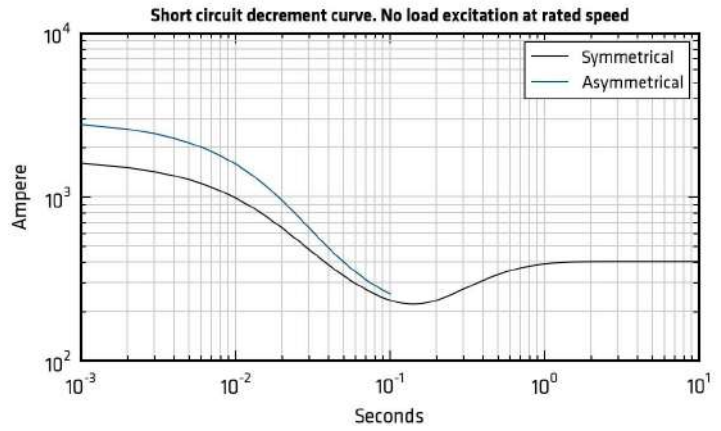

RPa: ; 9d; P

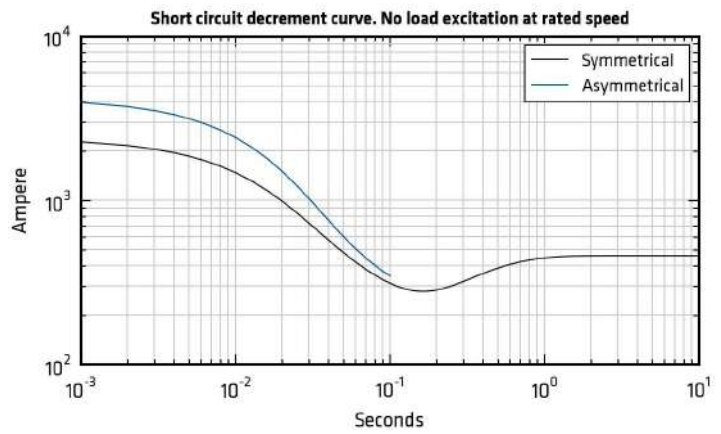

RPa: ; 8[; P

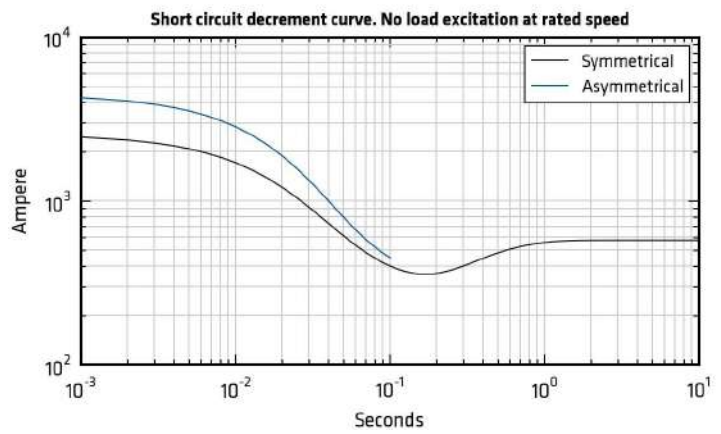

RPa: ; 9[; P

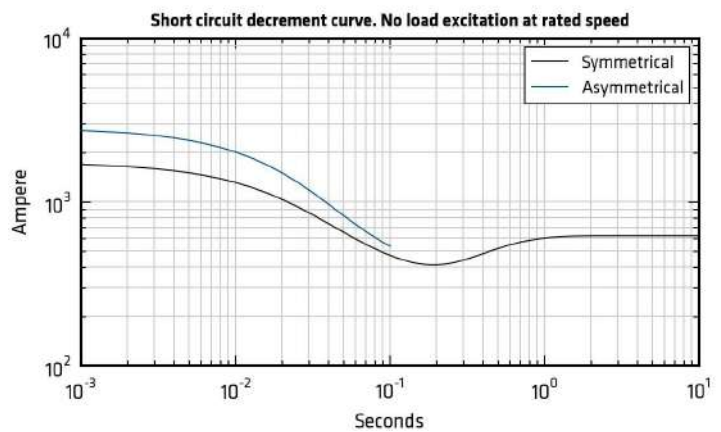

PEp

Ax

RPa: ; 8Z; P

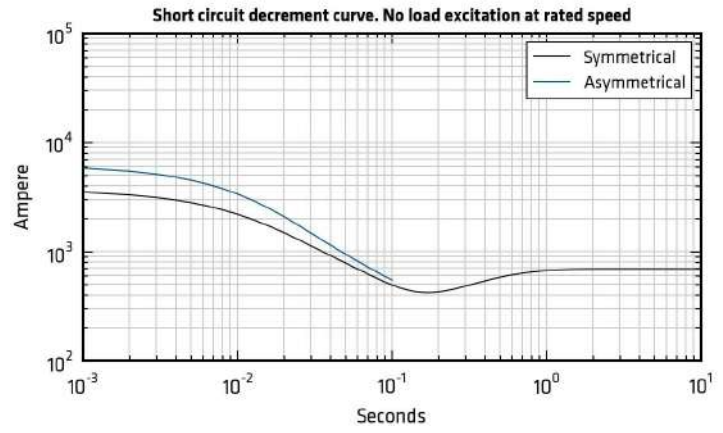

RPa: ; 9Z; P

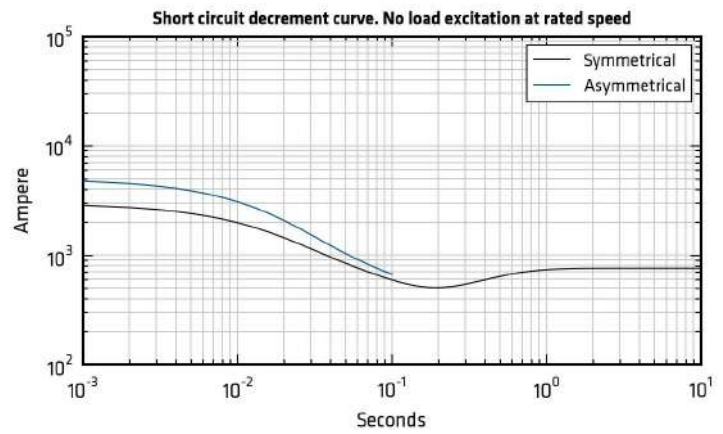

g i

| Qs s | RPa: ; 8l; P | | RPa: ; 9d; P | | RPa: ; 8l; P | | RPa: ; 9l; P | | RPa: ; 8Z; P | | RPa: ; 9Z; P | | |
|-------------------------------|--------------|-------|--------------|-------|--------------|-------|--------------|-------|--------------|-------|--------------|-------|-------|
| | -7U | @U | -7U | @U | -7U | @U | -7U | @U | -7U | @U | -7U | @U | |
| Qs w usyw | N ° ° | | | | | | | | | | | | |
| d s h ° v° y c w ° s uw/97 P0 | Ω | 0,033 | | 0,027 | | 0,021 | | 0,02 | | 0,014 | | 0,015 | |
| c h ° v° y c w ° s uw/97 P0 | Ω | 2,392 | | 2,844 | | 3,09 | | 3,172 | | 3,467 | | 3,624 | |
| d s R ū w c w ° s uw/97 P0 | Ω | 13,47 | | 13,47 | | 13,47 | | 13,47 | | 13,47 | | 13,47 | |
| c R ū w c w ° s uw/97 P0 | Ω | 0,36 | | 0,36 | | 0,36 | | 0,36 | | 0,36 | | 0,36 | |
| h w y z x u w w y w w s | kg | 302,0 | | 349,0 | | 385,0 | | 388,0 | | 423,0 | | 440,0 | |
| f t s s u w s y w ū | kN/mm | 4,8 | | 5,1 | | 5,3 | | 5,4 | | 5,5 | | 5,4 | |
| N° x | m³/min | 29,2 | 34,4 | 29,2 | 34,4 | 29,2 | 34,4 | 29,2 | 34,4 | 29,2 | 34,4 | 29,2 | 34,4 |
|] ° w w w s 8 6A | dB(A) | 79/65 | 83/69 | 79/65 | 83/69 | 79/65 | 83/69 | 79/65 | 83/69 | 79/65 | 83/69 | 79/65 | 83/69 |

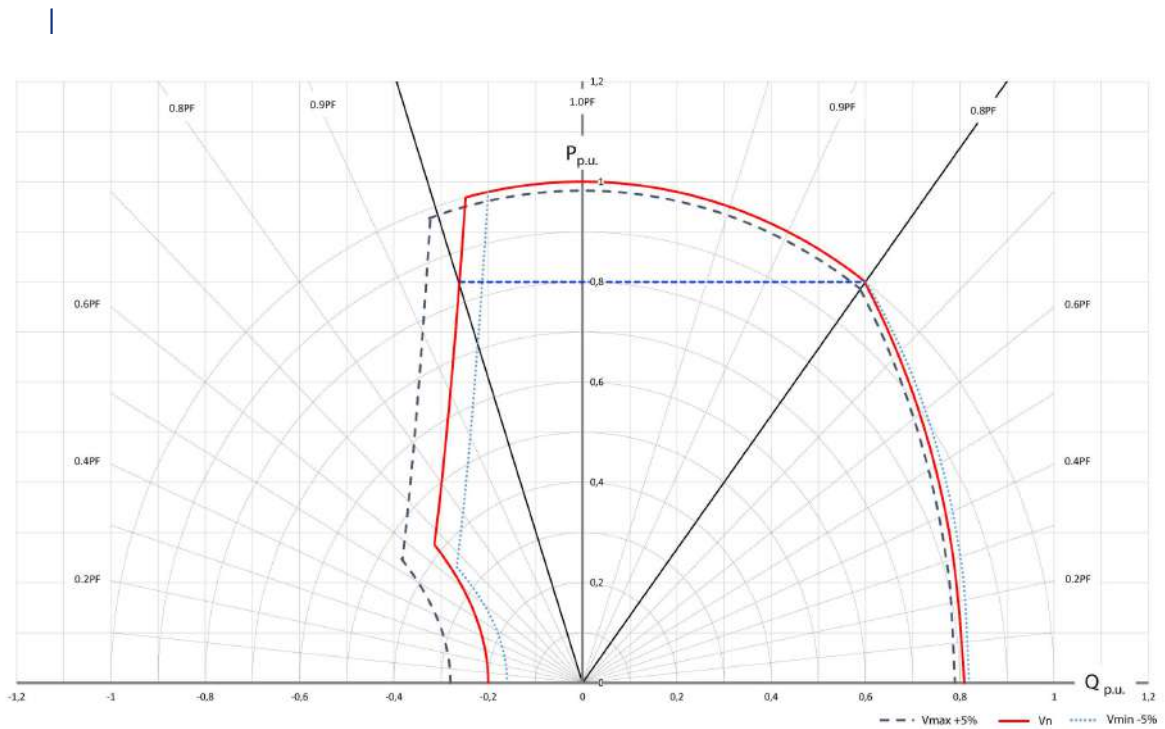

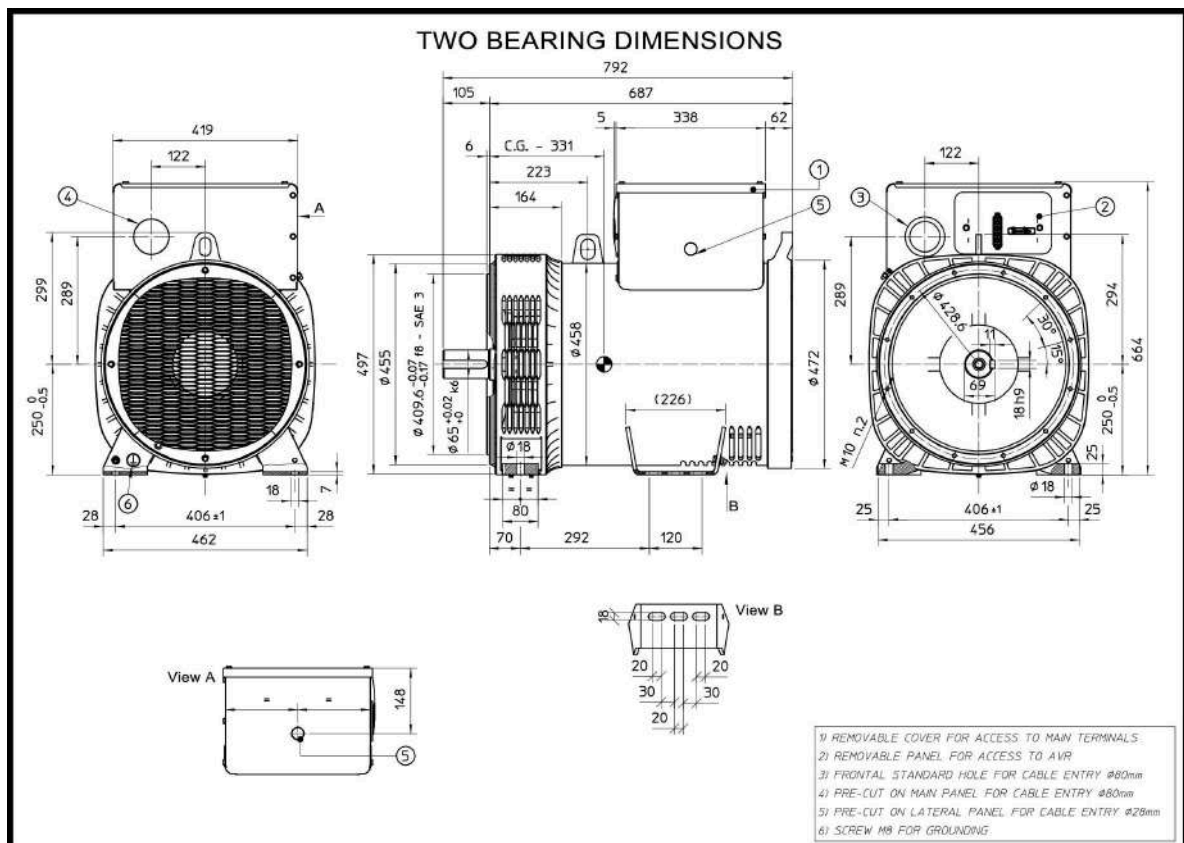
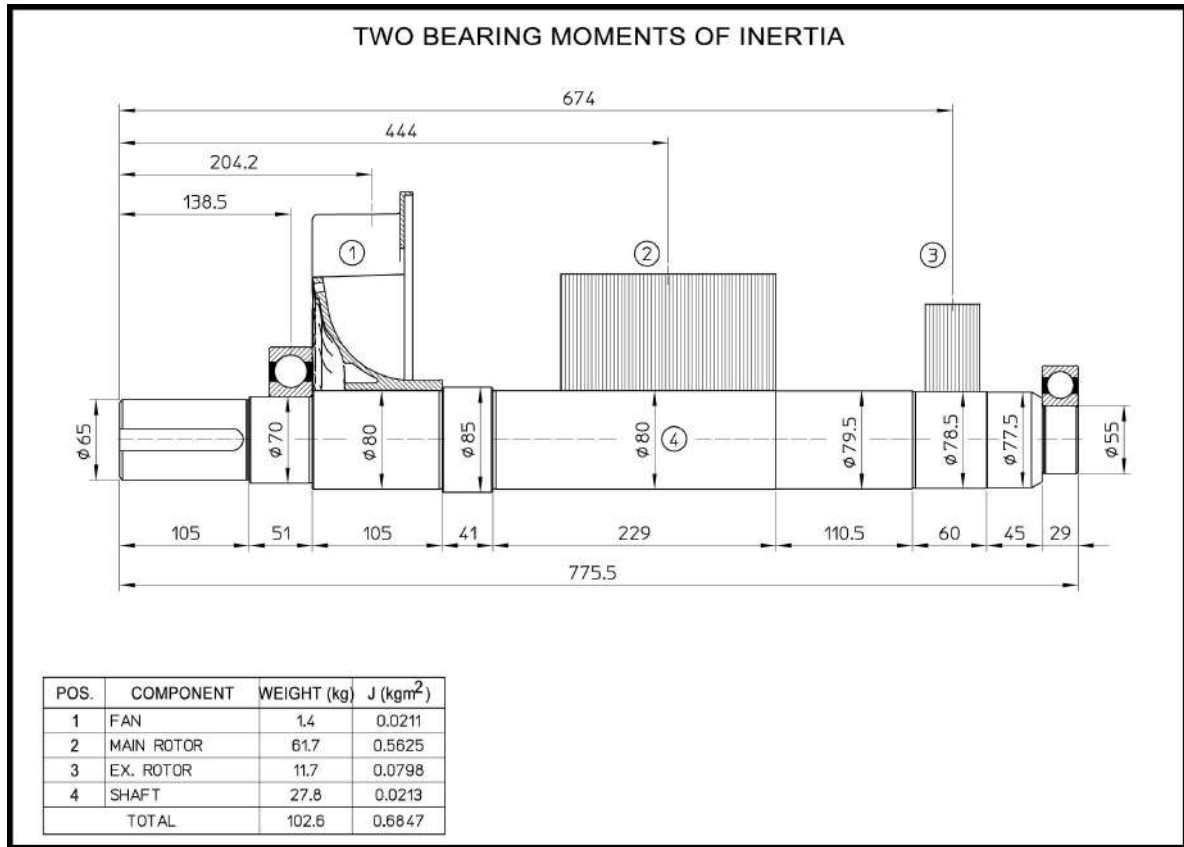

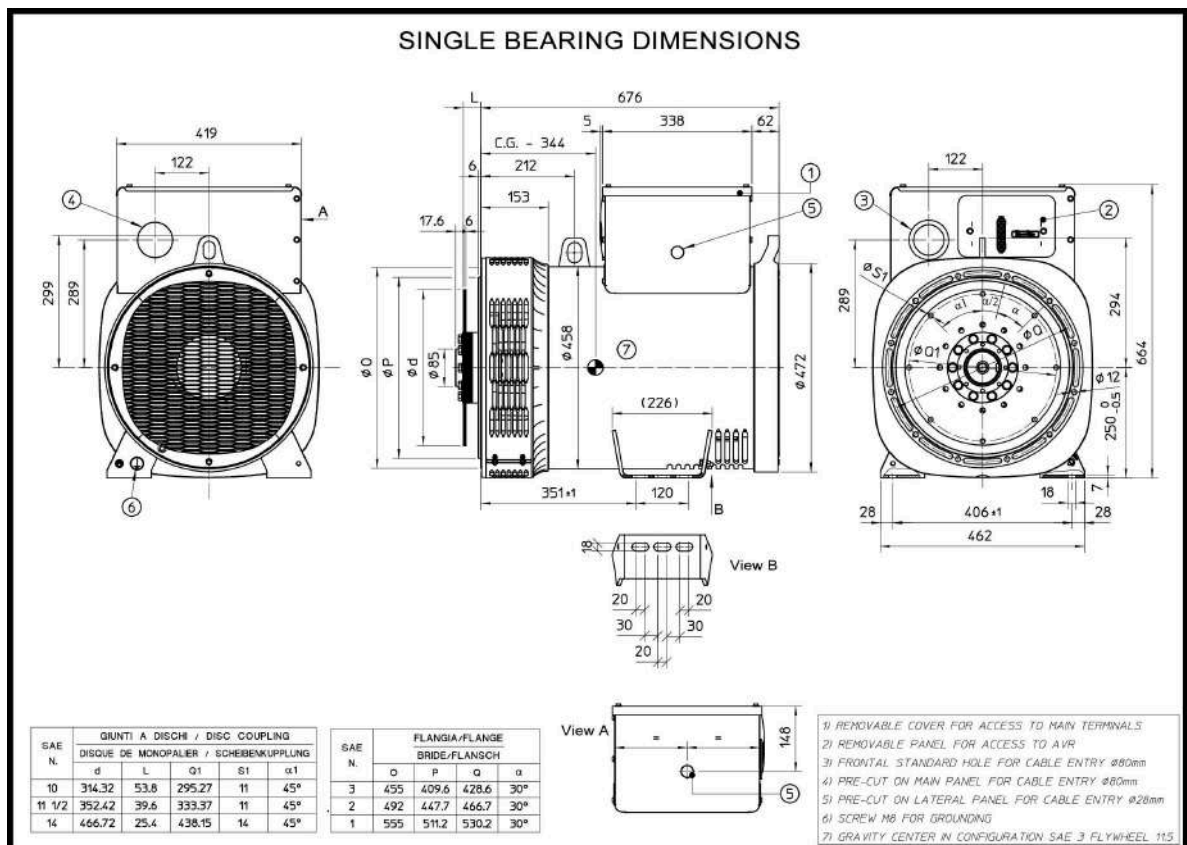
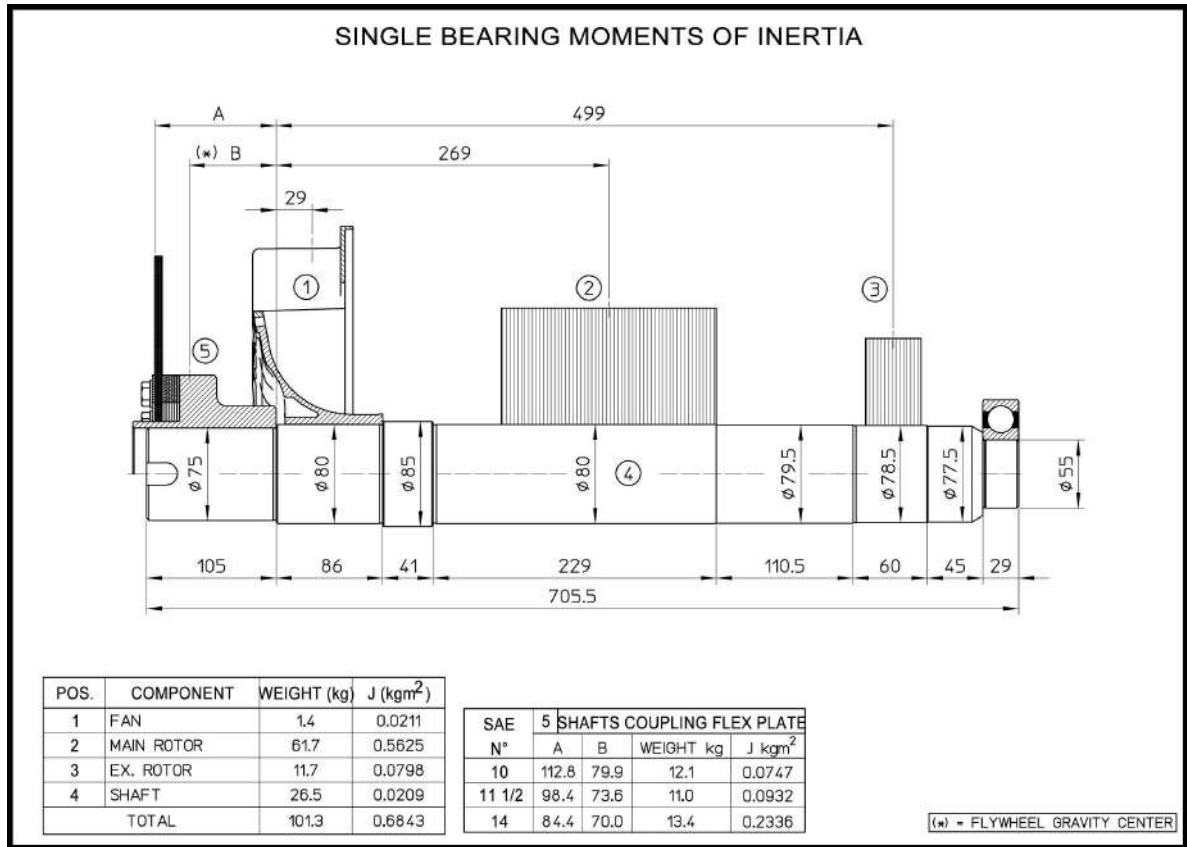

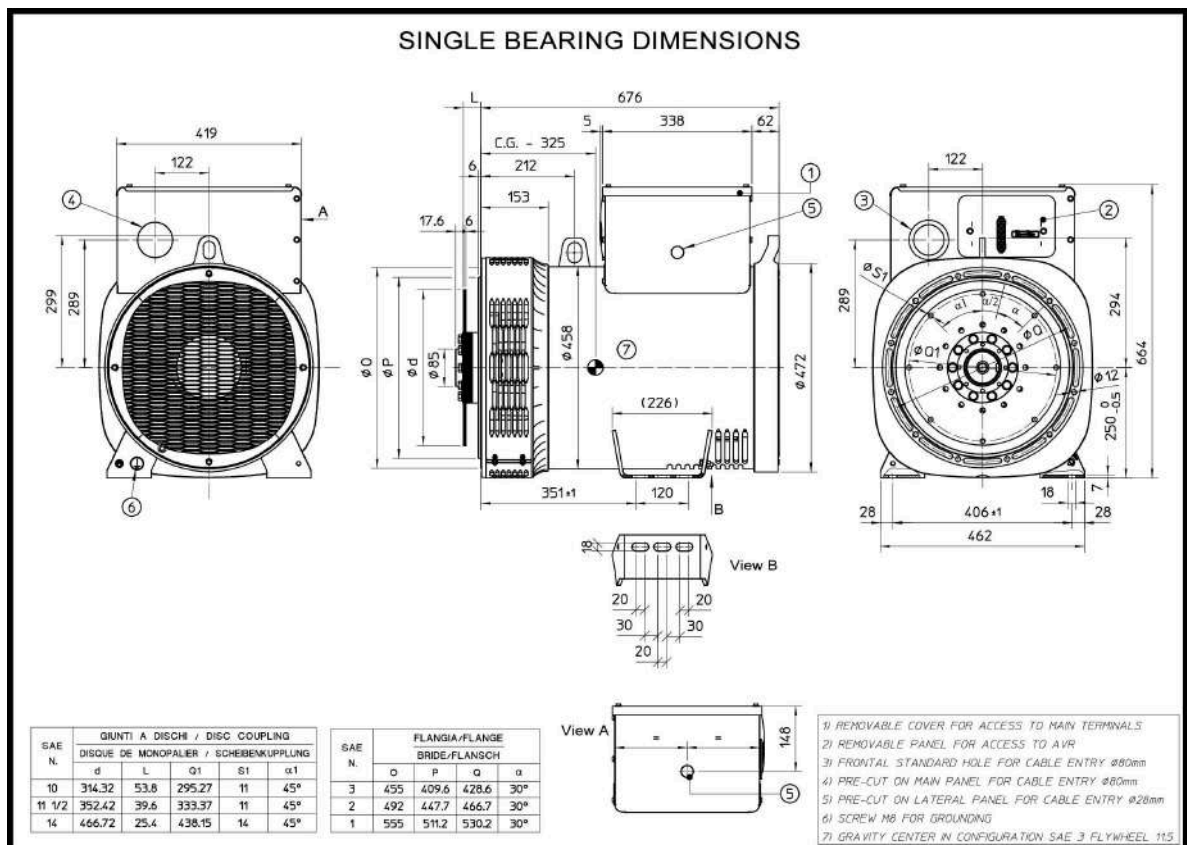
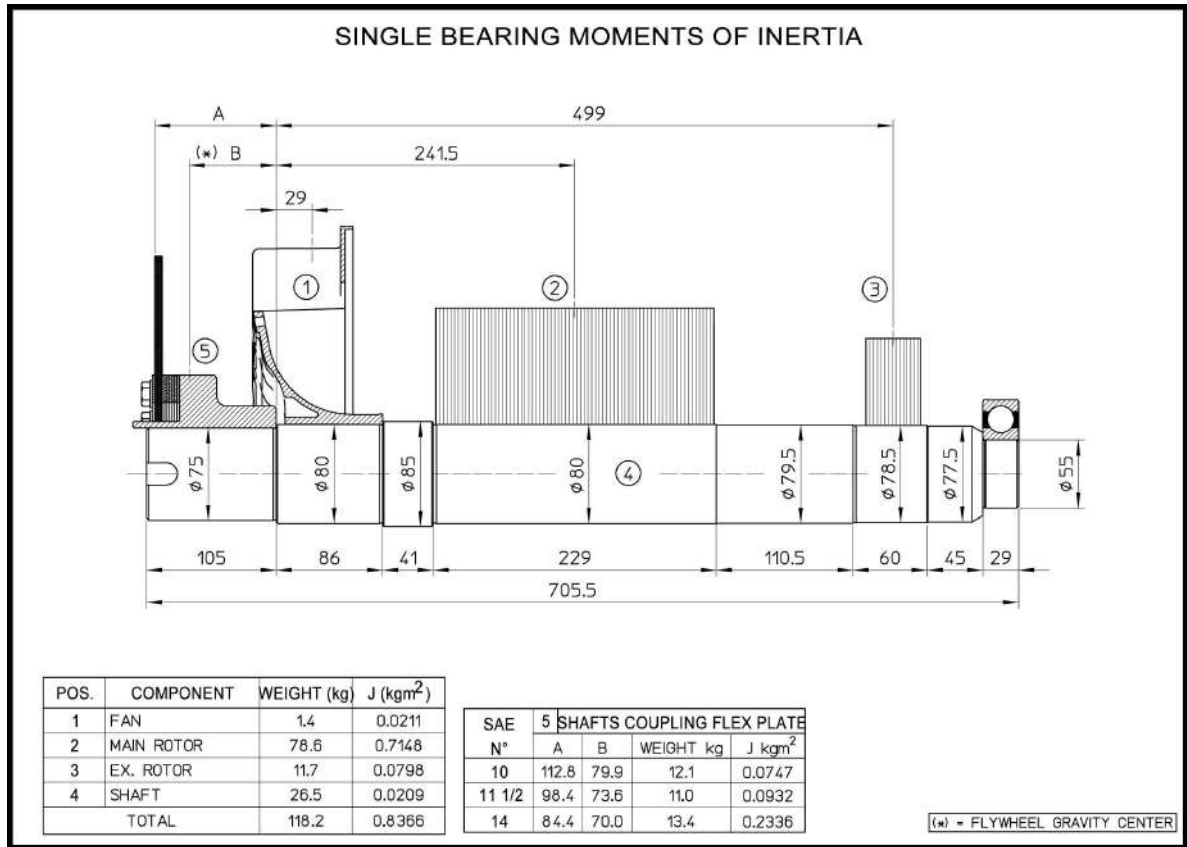

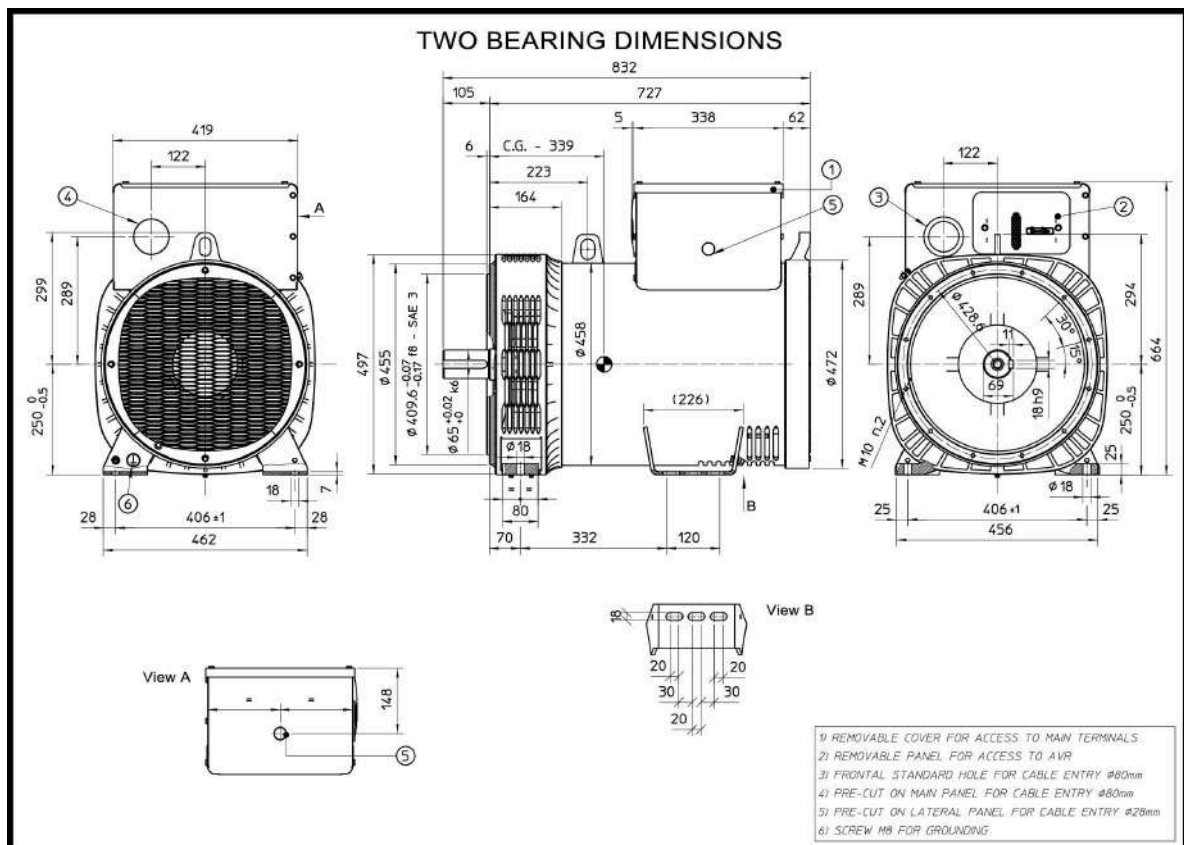
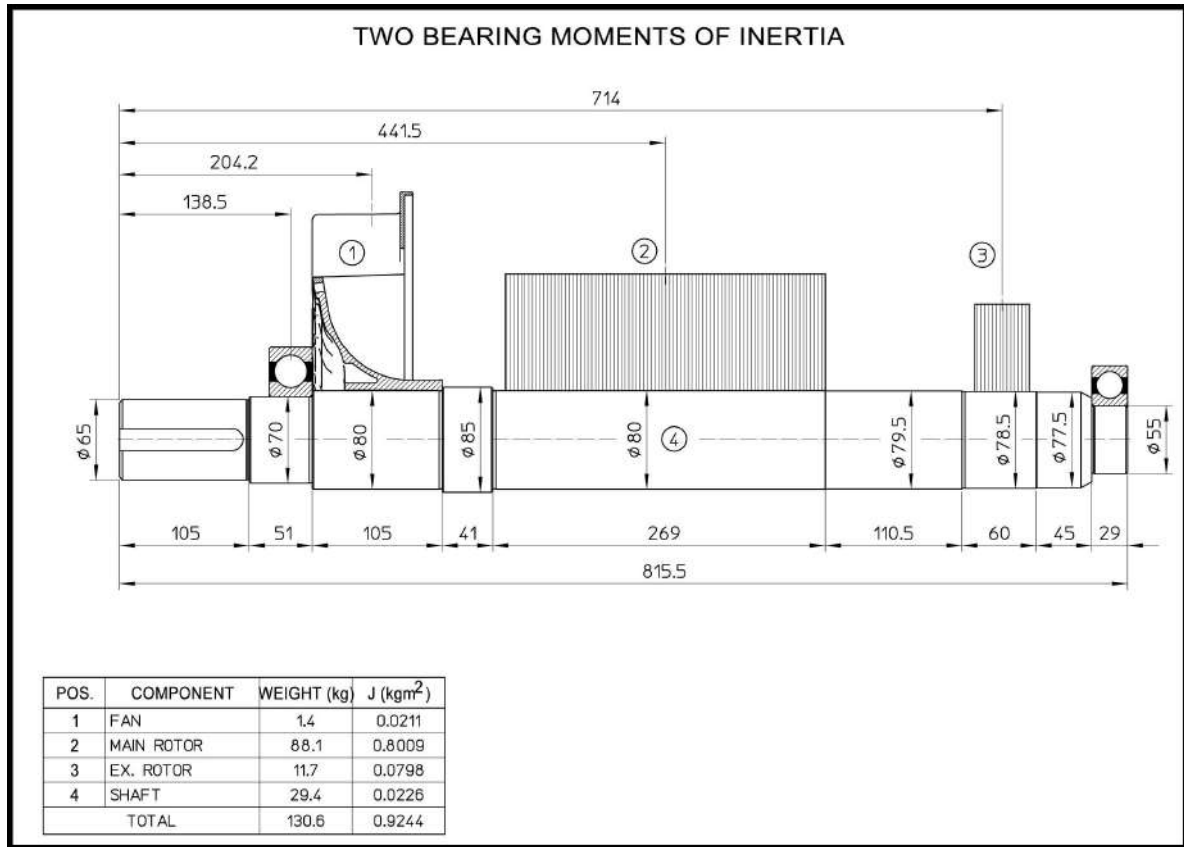

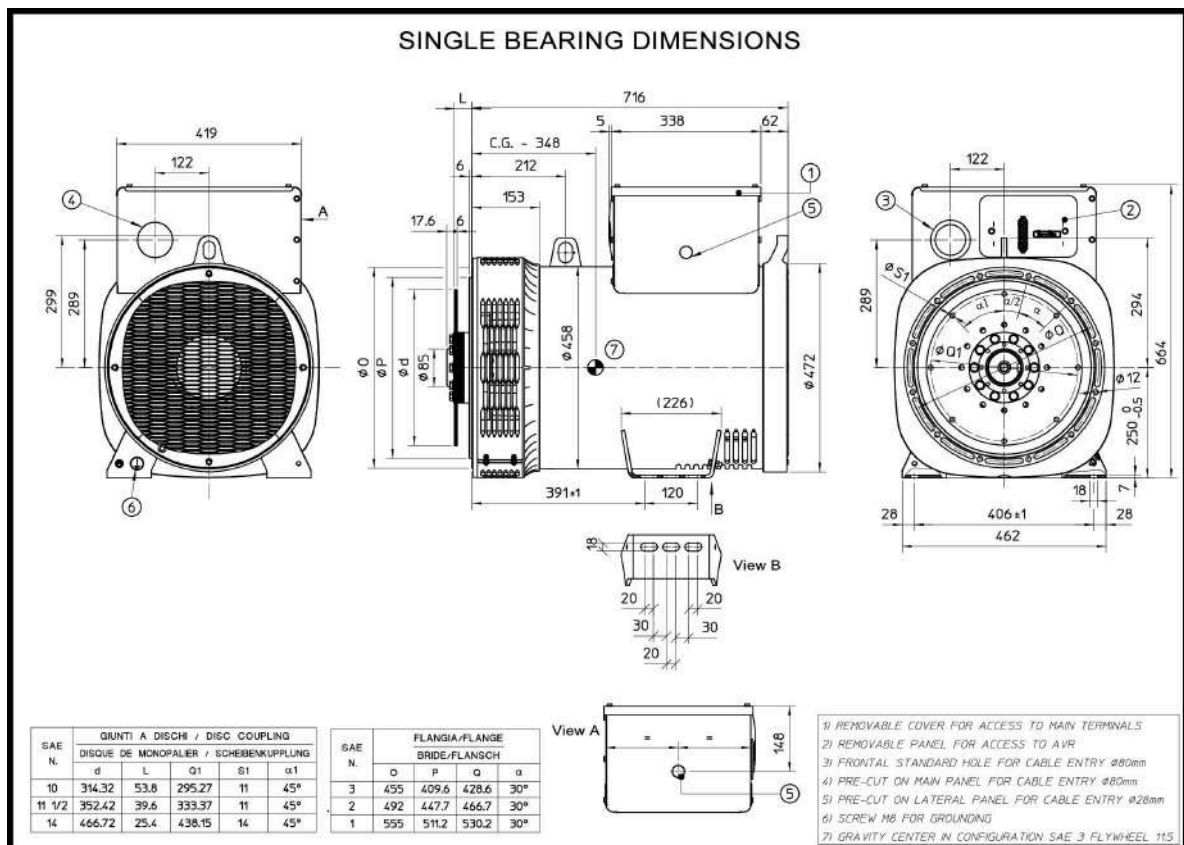
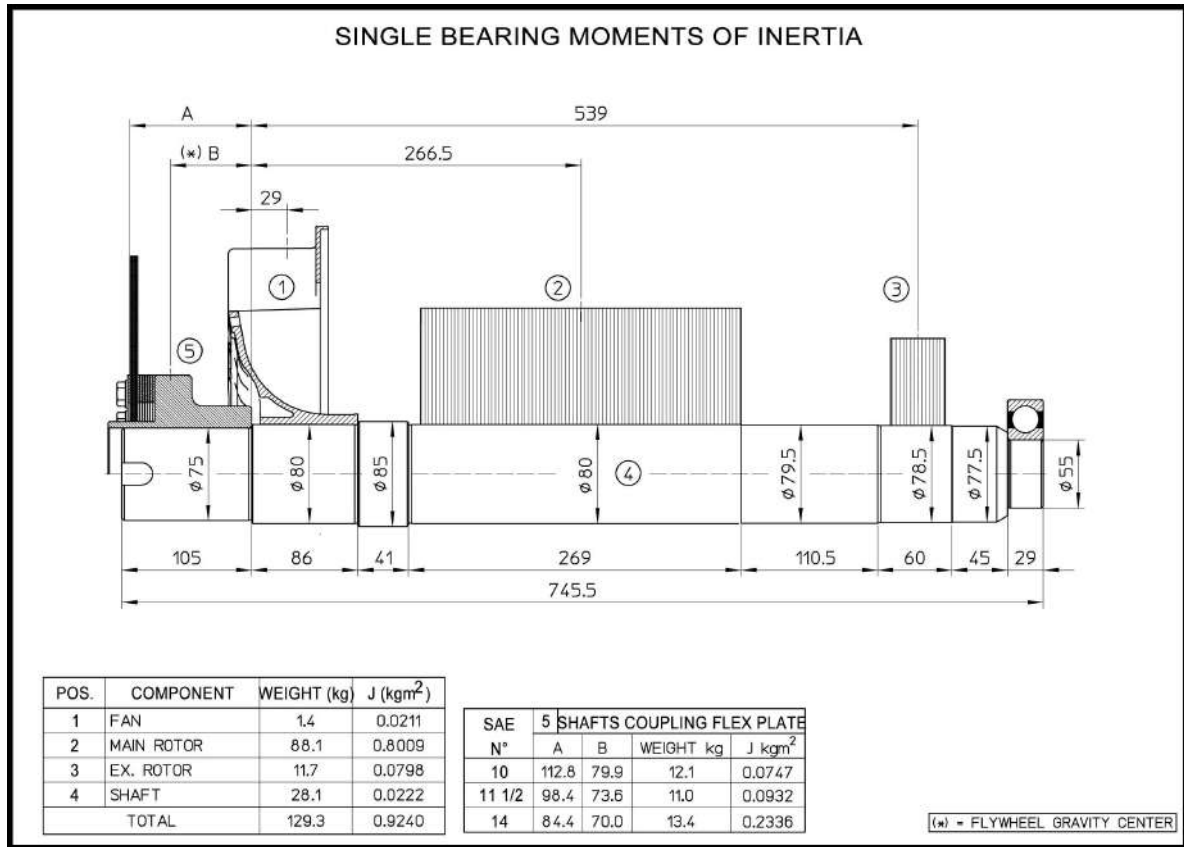

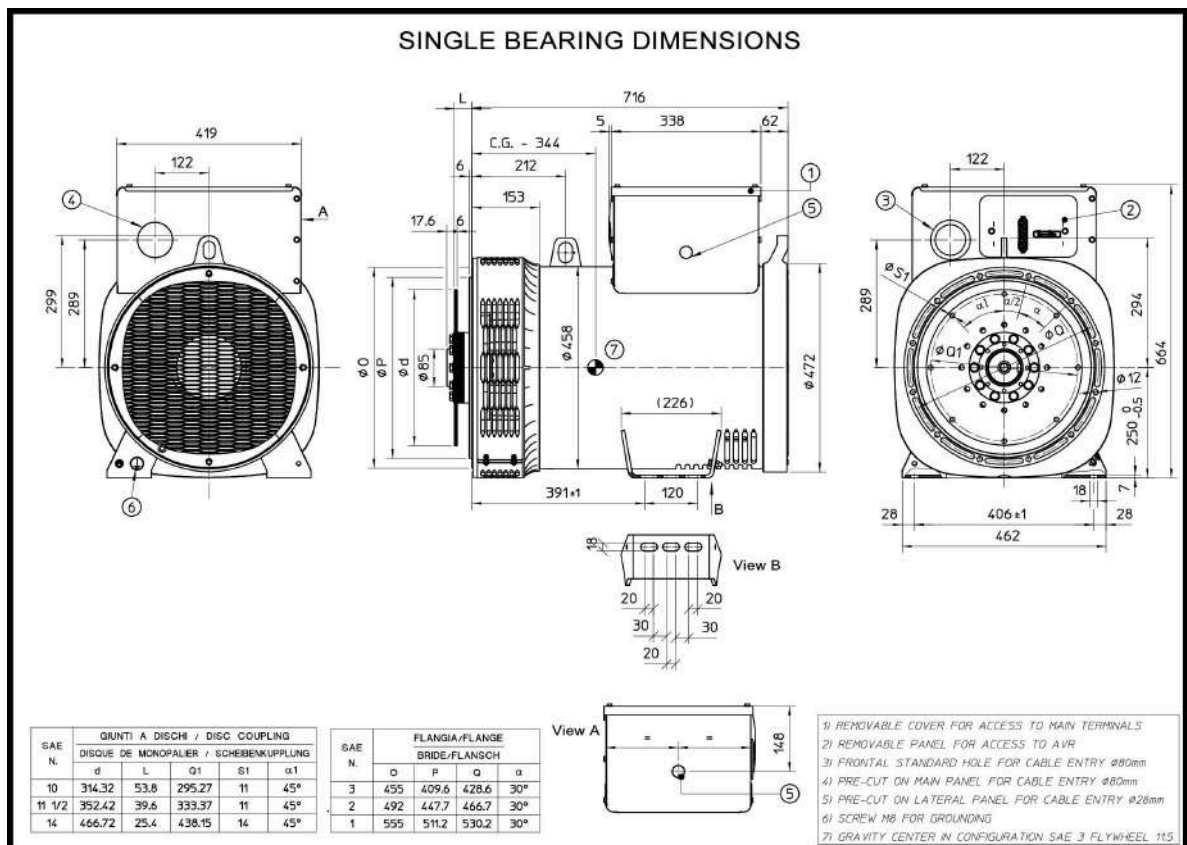
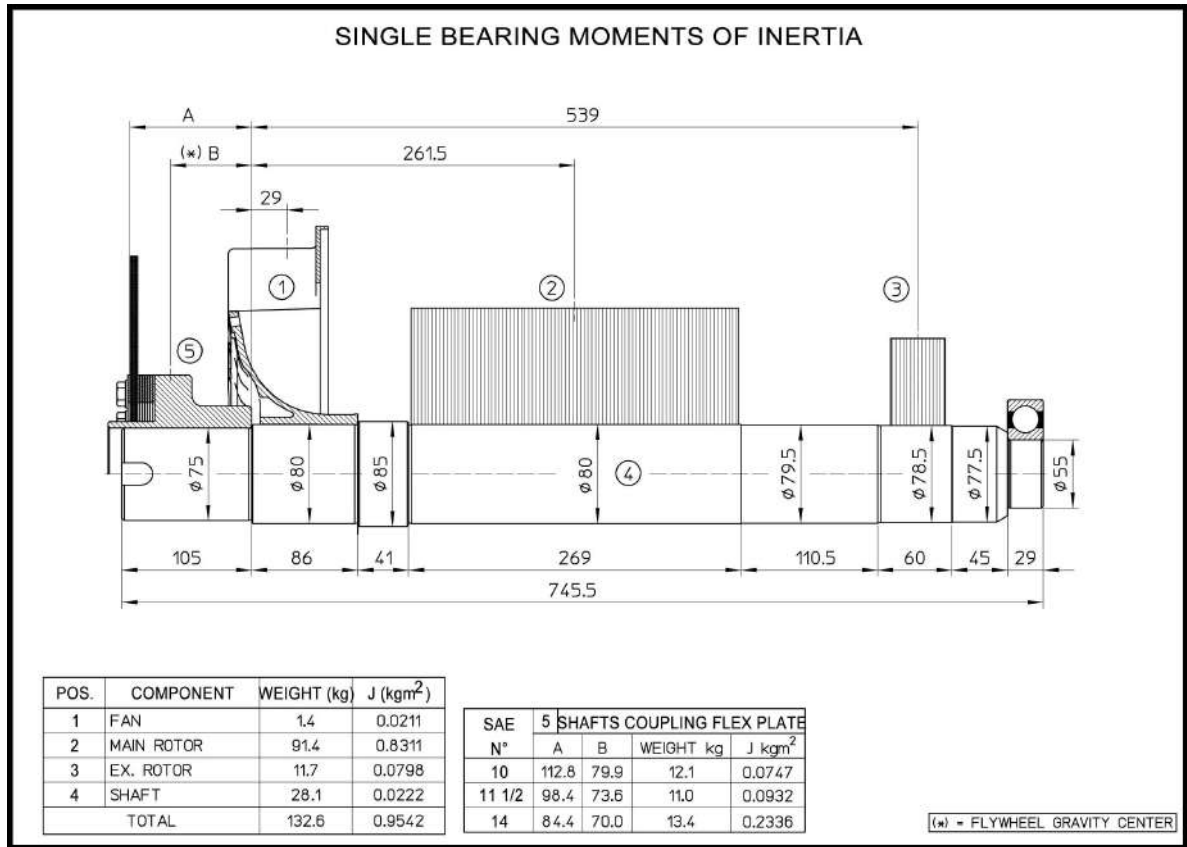

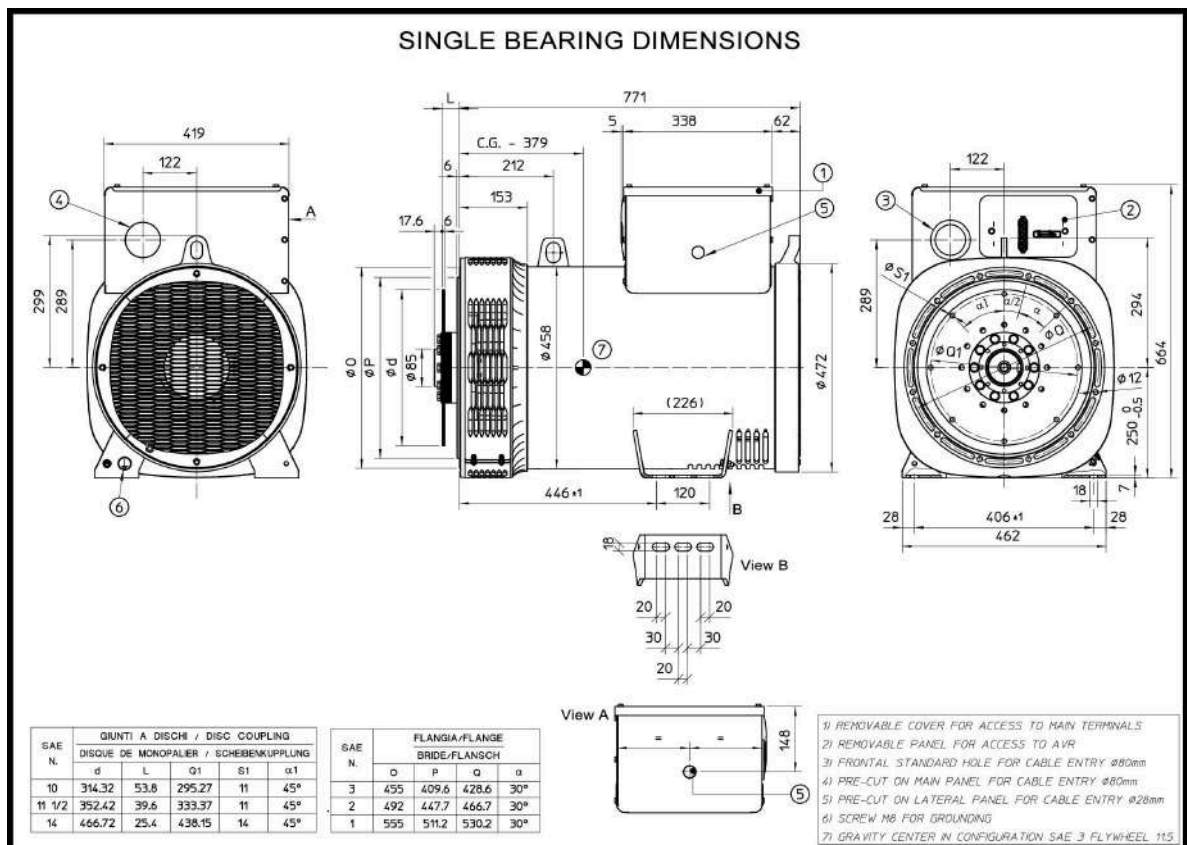
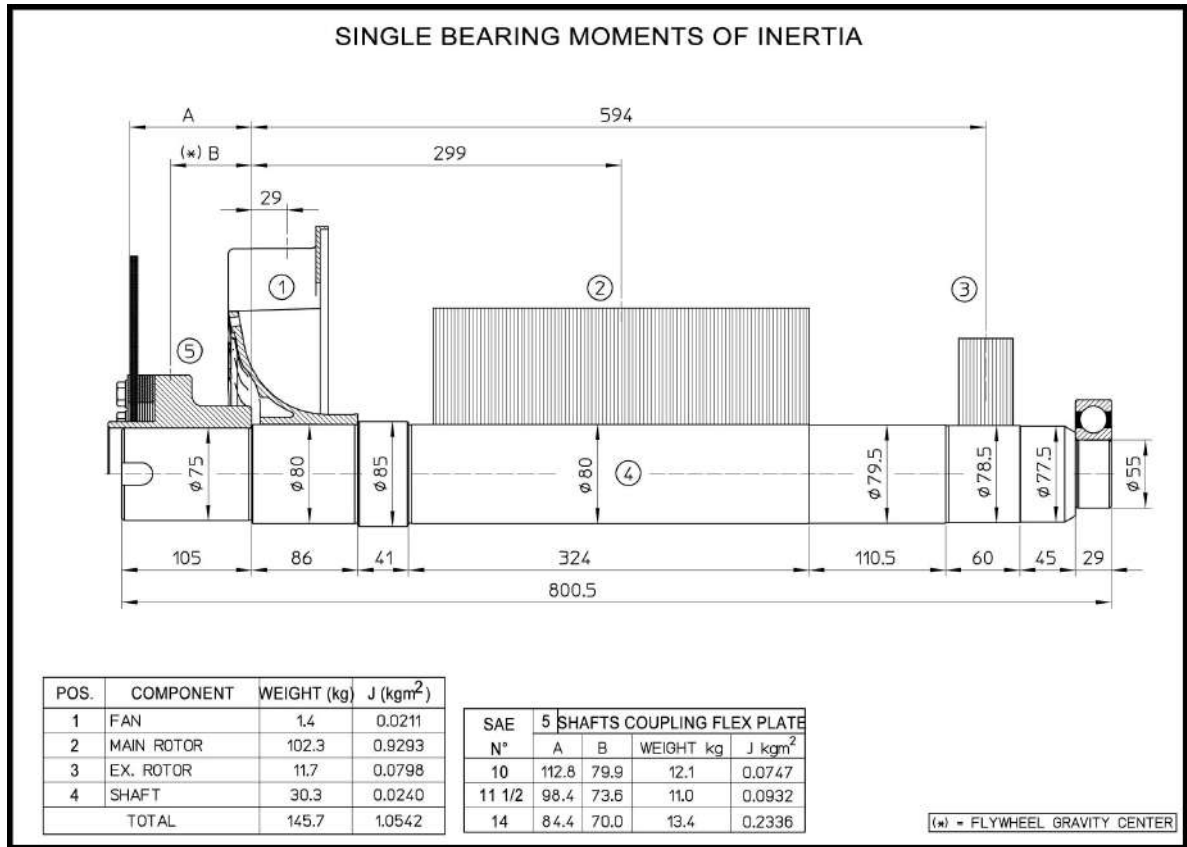

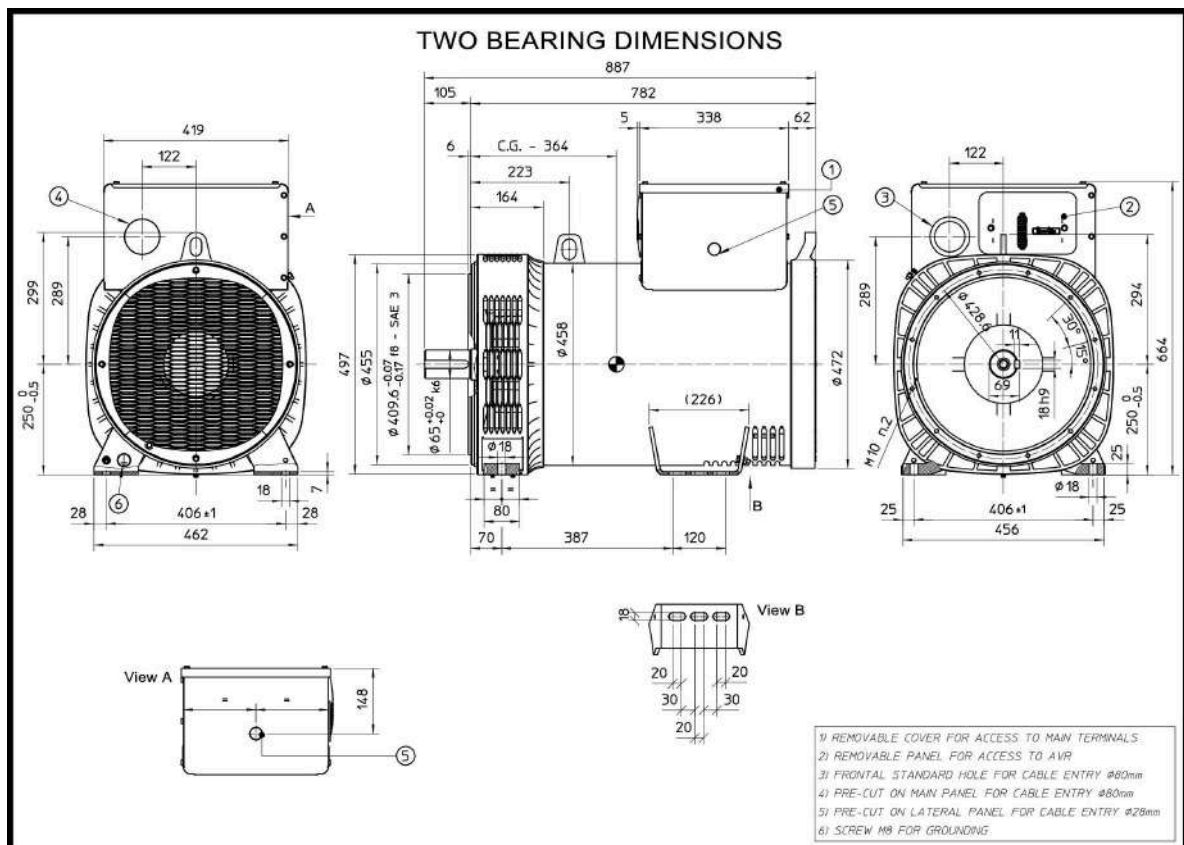
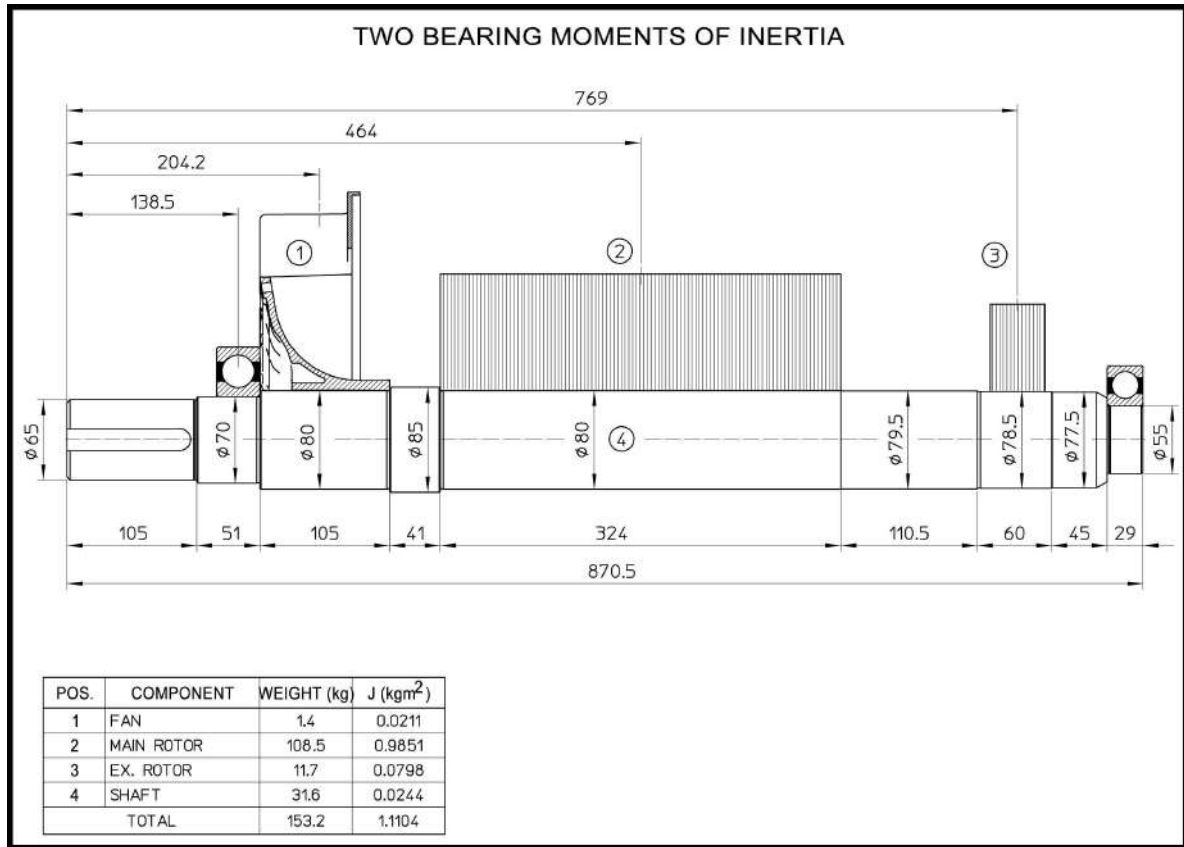

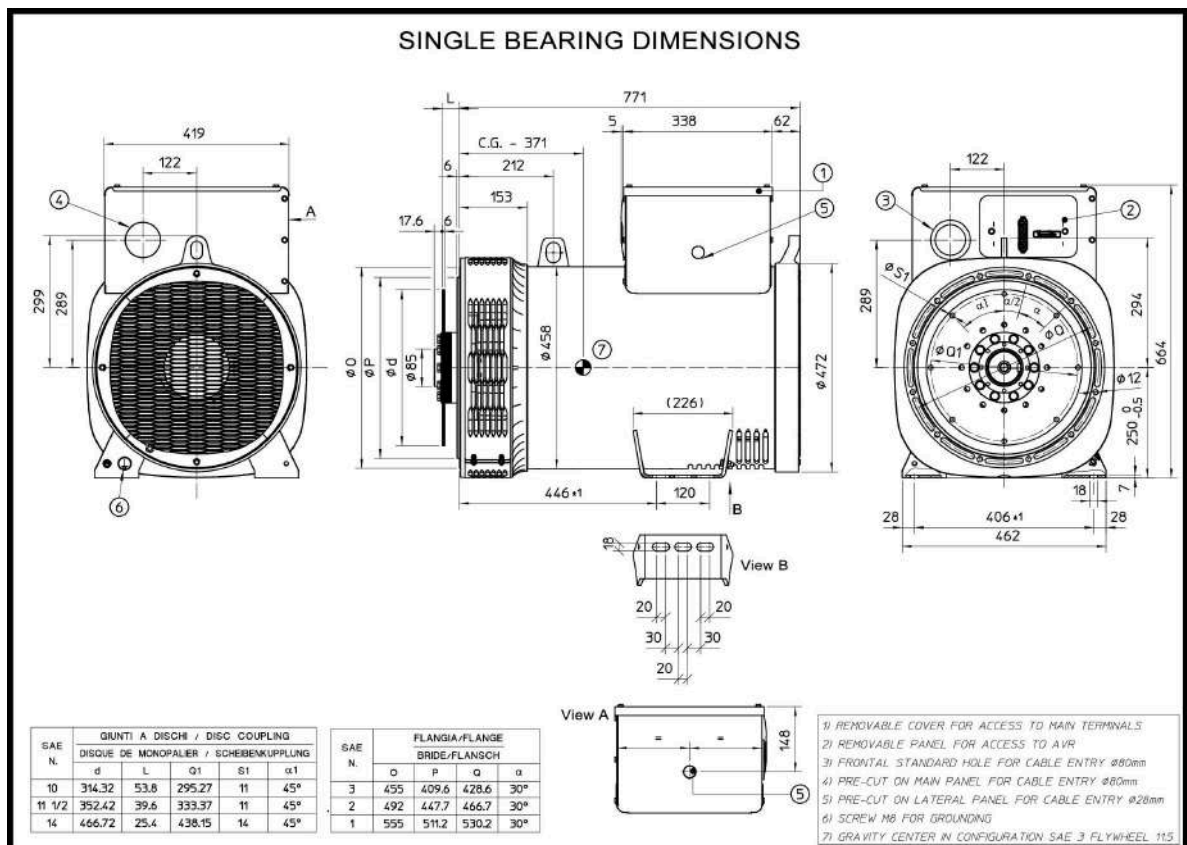
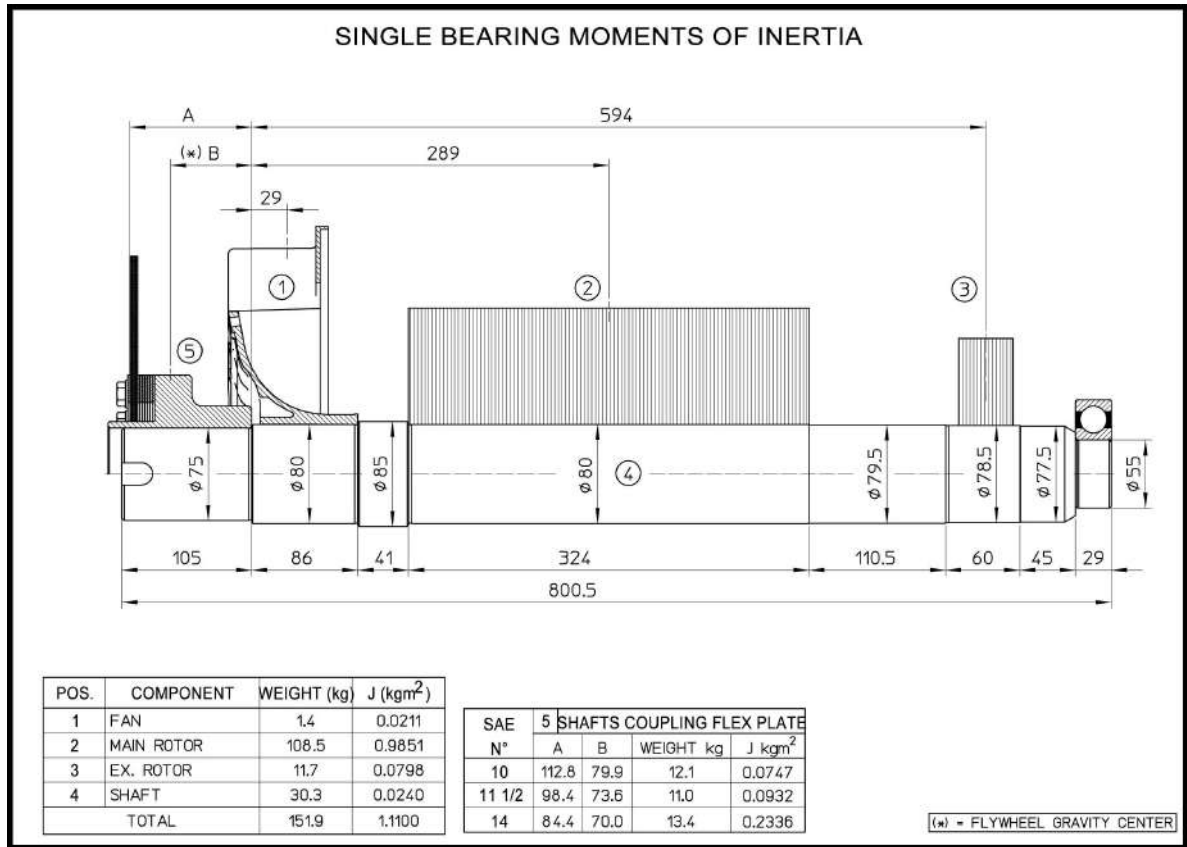

Mecc Alte SpA (HQ)

Via Roma
20 - 36051 Creazzo
Vicenza - ITALY
T: +39 0444 396111
F: +39 0444 396166
E: info@meccalte.it
aftersales@meccalte.it

Mecc Alte Portable

Via Roma
20 - 36051 Creazzo
Vicenza - ITALY
T: +39 0444 396111
F: +39 0444 396166
E: info@meccalte.it
aftersales@meccalte.it

Mecc Alte Power Products srl

Via Melaro
Z - 36075 Montecchio
Maggiore (VI) - ITALY
T: +39 0444 1831295
F: +39 0444 1831306
E: info@meccalte.it
aftersales@meccalte.it

Zanardi Alternatori srl

Via Dei Laghi
48/B - 36077 Altavilla
Vicenza - ITALY
T: +39 0444 370799
F: +39 0444 370330
E: info@zanardialternatori.it

United Kingdom

Mecc Alte U.K. LTD
6 Lands' End Way
Oakham
Rutland LE15 6RF
T: +44 (0) 1572 771160
F: +44 (0) 1572 771161
E: info@meccalte.co.uk
aftersales@meccalte.co.uk

Spain

Mecc Alte España S.A.
C/ Rio Taibilla, 2
Polig. Ind. Los Valeros
03178 Benijofar (Alicante)
T: +34 (0) 96 6702152
F: +34 (0) 96 6700103
E: info@meccalte.es
aftersales@meccalte.es

China

Mecc Alte Alternator Haimen LTD
755 Nanghai East Rd
Jiangsu HEDZ 226100 PRC
T: +86 (0) 513 82325758
F: +86 (0) 513 82325768
E: info@meccalte.cn
aftersales@meccalte.cn

India

Mecc Alte India PVT LTD
Plot NO: 1, Sanaswadi
Talegaon
Dhamdhare Road Taluka:
Shirur, District:
Pune - 412208
Maharashtra, India
T: +91 2137 619600
F: +91 2137 619699
E: info@meccalte.in
aftersales@meccalte.in

U.S.A. and Canada

Mecc Alte Inc.
1229 Adams Drive
McHenry, IL, 60051
T: +1 815 344 0530
F: +1 815 344 0535
E: info@meccalte.us
aftersales@meccalte.us

Germany

Mecc Alte Generatoren GmbH
Ensener Weg 21
D-51149 Köln
T: +49 (0) 2203 503810
F: +49 (0) 2203 503796
E: info@meccalte.de
aftersales@meccalte.de

Australia

Mecc Alte Alternators PTY LTD
10 Duncan Road, PO Box 1046
Dry Creek, 5094, South
Australia
T: +61 (0) 8 8349 8422
F: +61 (0) 8 8349 8455
E: info@meccalte.com.au
aftersales@meccalte.com.au

France

Mecc Alte International S.A.
Z.E.La Gagnerie
16330 ST.Amant de Boixe
T: +33 (0) 545 397562
F: +33 (0) 545 398820
E: info@meccalte.fr
aftersales@meccalte.fr

Far East

Mecc Alte (F.E.) PTE LTD
19 Kian Teck Drive
Singapore 628836
T: +65 62 657122
F: +65 62 653991
E: info@meccalte.com.sg
aftersales@meccalte.com.sg



www.meccalte.com