



Totally Focused. Totally Independent.

Technical Guide

RP[^] : B ; P

G-TYPE



Dynamic Data Support

The world's largest
independent producer of
alternators 1 – 5,000kVA

Standards

Alternators are designed and produced within an ISO 9001 environment. The entire series is manufactured according to, and complies with, the most common specifications such as CEI 2-3, IEC 34-1, EN 60034-1, VDE 0530, BS 4999-5000, NF 51.111, NEMA MG 1-2011, ISO 8528-3. They also comply with other specific standards such as UL1446, UL 1004/4 and /B and CAN/CSA-C22.2 No14-95-No100-95.

Windings and Performances

All windings are 2/3rds pitch to eliminate triplen harmonics within the voltage waveform and to avoid excessive neutral currents in certain parallel operating conditions. A fully interconnected aluminium or copper damper cage is supplied on the rotor of all models (excluding the ECP3 series).

- ▶ 12 wire reconnectable:
50Hz – 380V to 440V and 220/110V to 240/120V (de-rates may apply at certain voltages)
60Hz – 380V to 480V and 220/110V to 240/120V (de-rates may apply at certain voltages)
- ▶ 6 wire reconnectable:
50Hz – 380V to 440V and 220V to 240V (de-rates may apply at certain voltages)
60Hz – 380V to 480V and 220V to 240V (de-rates may apply at certain voltages)

Winding Configurations	Standard		Special (dedicated)			
	12 wire Reconnectable	6 wire Reconnectable	380V and 600V 60Hz	690V 50/60Hz	220-240V 1ph 50Hz	220-240V 1ph 60Hz
ECP3 to ECO38	Std	Option	Option	Option	Option	Option
ECO40	Std	Option	Option	Option	Option (to ECO40)	Option (to ECO40)
Insulation materials	Class H	Class H	Class H	Class H	Class H	Class H
High efficiency	Std	Std	Std	Std	Std	Std
High motor starting	>300%	>300%	>300%	>300%	>300%	>300%
THD (Total Harmonic Distortion)	Typically <3.5% full load L-L	Typically <3.0% full load L-L	Typically <3.5% full load L-L	Typically <3.5% full load L-L	Typically <4.5% full load L-N	Typically <4.5% full load L-N
Interference suppression	VDE 0875 C/N/K, EN61000-6-3, EN61000-6-2, others available on request					

Winding Protection

There are various degrees of protection for the windings following the standard impregnation process, as can be seen here. The TOTAL+ epoxy black coating is recommended for arduous applications.

Winding Protection:	STANDARD	STANDARD+	GREY	GREY+	TOTAL+
ECP3	Std	Option	Option	Option	Option
ECP28 and ECP32	-	Std	Option	Option	Option
NPE32, ECP34 to ECO40	-	-	Std	Option	Option

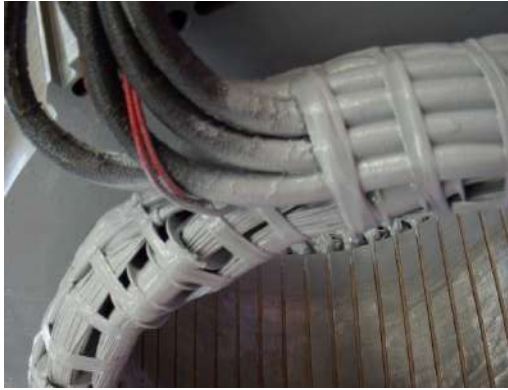

Grey treatment (marinization) on the left, TOTAL+ treatment shown on the right. The EG43 grey varnish, is a high temperature insulating enamel that forms a tough and flexible film, with excellent moisture and chemical protection. It is water and oil proof, and also protects windings from abrasion. It is applied spraying an over coating layer over the impregnated winding, or dipping the stator in a varnish barrel for superior treatments

The TOTAL+ is a protection system that makes Mecc Alte special. It is the ultimate winding treatment that offers truly superior performances when the environment is really harsh, or the application very demanding. The TOTAL+ is also extremely resistant to the particle abrasion as it adsorbs the impacts.

Protection for Environment

In addition to protection on the windings themselves, the alternators can have increased degree of protection. Standard level is IP23 but the following solutions are also available: IP23 DP with inlet filters, IP23 with only terminal box in IP45, IP43 and IP45. Derates may be applied.

Info: https://www.meccalte.com/downloads/MA0605_Bulletin_IP.pdf



Construction

The robust mechanical structure withstands up to 5G in any direction and 9G vertically and its design permits easy access to the connections and components during routine maintenance check-ups. The mechanical design has used the most advanced FEM techniques. The materials used are: FEP12 steel for the frame, C45 steel for the shaft and cast iron or aluminum pressure die cast for the end-brackets: fans are aluminum die casted either nylon fiber glass loaded, UL compliant materials. Rotors are dynamically balanced according grades 6.3 (up to series 32) or 2.5 (from series 34 onwards) of ISO 1940-1.

Terminals and Terminal Box

Easy access to regulators is possible due to a new AVR panel. Terminal boards have been redesigned into a special L configuration, specifically to ease customer connections; with this kind of terminal board it is possible to place a second terminal board in order to get 12 available terminals. Current transformers are available as an option on series ECO38 with single or dual output.

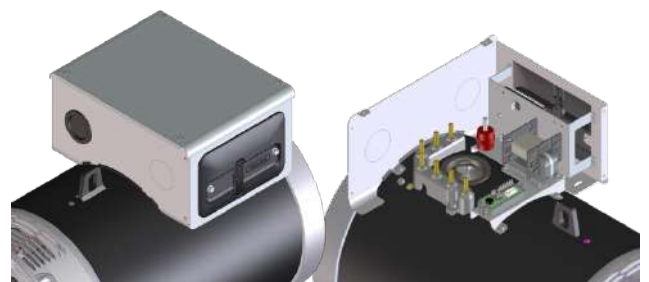

Excitation and Regulation Systems

All ECP/ECO series have MAUX auxiliary winding to power the digital regulator. Both DSR and the DER1 are available to connect to PC through the DxR2 USB interface and DxR TERMINAL software to interrogate/download alarms & settings for analysis or for cloning other regulators. DER2 has got an integrated USB connection and can be connected to the PC without any optional connection boards. More settings such as LAMS, digital RAM based synchronous external control and soft start are obtainable through the DxR connection. Simple analogue potentiometers are available for the more usual adjustments.

Excitation Systems	DSR	DER1	DER2
ECP3 to ECO38	Std	Option	Option
ECO40	-	Std	Option
Parallel Operation	√	√	√
Mains Parallel	√	√	√
3 Phase Sensing (rms)	-	√	√
Accuracy	+/-1%	+/-0.5%	+/-0.5%
Remote Voltage Control	√	√	√
Alarm Log	√	√	√
Analogue and Digital Configurable	√	√	√
LAMS (Load Acceptance V/f)	√	√	√
APO (Active Protection Output)	√	√	√
Soft Start	√	√	√
High dynamic response	-	-	√
USB connection without external boards	-	-	√

For a given motor start duty a smaller machine may be selected – also enhanced by low sub-transient reactance values for non-linear loads. The whole range is capable of >300% sustained short circuit current for up to 20 seconds.

Optional PMG

The Mecc Alte PMG is available on ECP28, ECP32, ECP34 and ECO38 as factory-fitted option; alternatively, only the predisposition for the retrofit, for subsequent assembly, is available on option. On series ECO40 is available as a factory-fitted or retro-fitted options.

The complete AVR range is fully compatible with both MAUX and PMG systems; this minimises spare parts management and flexibility of stock as one AVR suits all applications.

The PMG is delivering the same amount of kVA available with the MAUX.



Dew Heater

Our whole range can be fitted with anti-condensation heaters of adequate power sized to alternator kVA. Voltage for heaters must be specified when ordering. New cylindrical cartridge style heaters are available on request and it can be retrofitted.

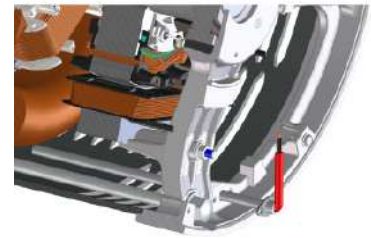

Accessories

Additional optionals can be fit on our alternator series, such as PTC thermistors or PT100 both on windings and bearings, dew heaters, high and low profile of terminal boxes (on most series), parallel devices (standard from ECO38), current and voltage transformers, air filters, IP43 and IP45 protections and many others.

For more info visit: <https://www.meccalte.com/en/products/alternators/accessories/c-type-accessories>

Deration coefficients

Altitude (meters)	Ambient temperature (Celsius)					
	25	40	45	50	55	60
≤ 1000	1.07	1	0.96	0.93	0.91	0.89
$> 1000 \leq 1500$	1.01	0.96	0.92	0.89	0.87	0.84
$> 1500 \leq 2000$	0.96	0.91	0.87	0.84	0.83	0.79
$> 2000 \leq 3000$	0.9	0.85	0.81	0.78	0.76	0.73

Notes on short circuit curves

The indicated coefficients have to be used to correct the three phase short circuit curves values as a function of the rated voltage.

The indicated coefficient have to be used to correct the three phase short circuit curves values as a function of the type of short circuit voltage.

50 Hz		60 Hz	
Voltage	Factor	Voltage	Factor
380	0.93X	415	0.85X
400	1X	440	0.90X
415	1.04X	460	0.95X
440	1.10X	480	1X

	3 phase	2 phase L-L	1 phase L-N
<i>Istantaneous</i>	1X	0.87X	1.30X
<i>Minimum</i>	1X	1.80X	3.20X
<i>Sustained</i>	1X	1.50X	2.50X
<i>Max Duration</i>	20 sec.	10 sec.	4 sec.

All the curves are shown for series or parallel star connection at 400V 50 Hz or 480V 60 Hz. If the unit is reconnected from series to parallel star, the additional coefficient is 2X. From series star to series delta, it is 1.72X. From series star to parallel delta, it is 3.44X.

S

a w tw	:	V s ° us	U
azs w tw	:	a wu ° us	U9:
] tw x ° w	⊗] QRQvs ° y w	@ & 9c d
R wu °	O z w	QRQvs ° y w	@ 89c d
c wv s w	Qdc	[s ° ^ w wv	99=7
h ° v ° y ° uz	96:	N ° v w	748777
P v w syw wv wv wv	e7; 7=d:	Qs s u° y	Vd ^ 8c; 748

RHt

gN6 h Mew 5c ° w6N t° w P479a5																				
deN] Q0k48@ 69A				deN] Q0k48-7; 7				U487=6; 7				S487=6; 7				O487; 7				
dw° w d s k	: B7g	: 77g	: 8-g	: ; 7g	: B7g	: 77g	: 8-g	: ; 7g	: B7g	: 77g	: 8-g	: ; 7g	: B7g	: 77g	: 8-g	: ; 7g	: B7g	: 77g	: 8-g	: ; 7g
as s w d s kk	8C7g	977g	97Bg	997g	8C7g	977g	97Bg	997g	8C7g	977g	97Bg	997g	8C7g	977g	97Bg	997g	8C7g	977g	97Bg	997g
dw° w Qw s Δ	997g	9: 7g	9: 7g	9=; g	997g	9: 7g	9: 7g	9=; g	997g	9: 7g	9: 7g	9=; g	997g	9: 7g	9: 7g	9=; g	997g	9: 7g	9: 7g	9=; g
as s w Qw s ΔΔ	887g	88-g	887g	88Ag	887g	88-g	887g	88Ag	887g	88-g	887g	88Ag	887g	88-g	887g	88Ag	887g	88-g	887g	88Ag
W S k	196	196	196	180	188	188	188	173	180	180	180	165	170	170	170	155	144	144	144	132
	157	157	157	144	150	150	150	138	144	144	144	132	136	136	136	124	115	115	115	106
W V k	220	220	220	209	211	211	211	200	200	200	200	190	185	185	185	175	160	160	160	152
	176	176	176	167	169	169	169	160	160	160	160	152	148	148	148	140	128	128	128	122
W S k	250	250	250	234	237	237	237	221	225	225	225	210	207	207	207	190	180	180	180	168
	200	200	200	187	190	190	190	177	180	180	180	168	166	166	166	152	144	144	144	134
W V k	275	275	275	253	264	264	264	243	250	250	250	230	230	230	230	215	200	200	200	184
	220	220	220	202	211	211	211	194	200	200	200	184	184	184	184	172	160	160	160	147
W S k	330	330	330	319	315	315	315	305	300	300	300	290	275	275	275	265	240	240	240	232
	264	264	264	255	252	252	252	244	240	240	240	232	220	220	220	212	192	192	192	186
W V k	370	370	370	360	360	360	360	350	350	350	350	340	320	320	320	310	280	280	280	272
	296	296	296	288	288	288	288	280	280	280	280	272	256	256	256	248	224	224	224	218
W k	380	400	400	370	370	380	380	360	360	370	370	350	329	338	338	319	288	296	296	280
	304	320	320	296	296	304	304	288	288	296	296	280	263	270	270	255	230	237	237	224

SHt

gN6 h Mew 5c ° w6N t° w P479a5																				
deN] Q0k48@ 69A				deN] Q0k48-7; 7				U487=6; 7				S487=6; 7				O487; 7				
dw° w d s k	: 8-g	: ; 7g	: @g	: B7g	: 8-g	: ; 7g	: @g	: B7g	: 8-g	: ; 7g	: @g	: B7g	: 8-g	: ; 7g	: @g	: B7g	: 8-g	: ; 7g	: @g	: B7g
as s w d s kk	97Bg	997g	9: 7g	9: 7g	97Bg	997g	9: 7g	9: 7g	97Bg	997g	9: 7g	9: 7g	97Bg	997g	9: 7g	9: 7g	97Bg	997g	9: 7g	9: 7g
dw° w Qw s Δ	9: 7g	9=; g	9@-g	9AAg	9: 7g	9=; g	9@-g	9AAg	9: 7g	9=; g	9@-g	9AAg	9: 7g	9=; g	9@-g	9AAg	9: 7g	9=; g	9@-g	9AAg
as s w Qw s ΔΔ	887g	88Ag	8: g	8 Bg	887g	88Ag	8: g	8 Bg	887g	88Ag	8: g	8 Bg	887g	88Ag	8: g	8 Bg	887g	88Ag	8: g	8 Bg
W S k	225	236	236	236	220	230	230	230	210	220	220	220	195	205	205	205	168	176	176	176
	180	189	189	189	176	184	184	184	168	176	176	176	156	164	164	164	134	141	141	141
W V k	253	264	264	264	242	253	253	253	230	240	240	240	210	220	220	220	184	192	192	192
	202	211	211	211	194	202	202	202	184	192	192	192	168	176	176	176	147	154	154	154
W S k	289	300	300	300	274	284	284	284	260	270	270	270	240	250	250	250	208	216	216	216
	231	240	240	240	219	227	227	227	208	216	216	216	192	200	200	200	166	173	173	173
W V k	319	330	330	330	305	316	316	316	290	300	300	300	270	280	280	280	232	240	240	240
	255	264	264	264	244	253	253	253	232	240	240	240	216	224	224	224	186	192	192	192
W S k	358	374	396	396	341	357	378	378	325	340	360	360	300	310	330	330	260	272	288	288
	286	299	317	317	273	286	302	302	260	272	288	288	240	248	264	264	208	218	230	230
W V k	402	444	444	444	391	438	438	438	380	420	420	420	350	385	385	385	304	336	336	336
	322	355	355	355	313	350	350	350	304	336	336	336	280	308	308	308	243	269	269	269
W k	413	455	455	465	401	442	442	453	390	430	430	440	359	394	394	403	312	344	344	352
	330	364	364	372	321	354	354	362	312	344	344	352	287	315	315	322	250	275	275	282

4 Dn t GQH

f s s vw / wSR] @7.; 4 0	RP^: B 8d; P	RP^: B 9d; P	RP^: B 8; P	RP^: B 9[; P	RP^: B 8Z; P	RP^: B 9Z; P	RP^: B gZ; P
Xd Q° wu 4s ° uz v6u s uw %	203,9	207	198,7	214,2	215,3	222,5	226,3
X'd Q° wu 4s ° s 'w v6u s uw %	10	11,4	12,7	14,5	15,8	17,8	19,2
X''d Q° wu 4s ° t s 'w v6u s uw %	5,69	6,11	6,72	7,45	8,38	9,73	10,8
Xq b sv s w4s ° uz v6u s uw %	100,3	113,8	109,7	121,1	124,2	130,4	135,6
X'q b sv s w4s ° s 'w v6u s uw %	100,3	113,8	109,7	121,1	124,2	130,4	135,6
X''q b sv s w4s ° t s 'w v6u s uw %	20,4	22,2	23	22,8	21,5	20,8	20,1
X2] wv s ° w4 w w uw v6u s uw %	13,2	14,8	15,9	16,6	16,7	16,2	15,6
Xo l w w w uw v6u s uw %	2,79	2,59	2,69	2,48	2,38	2,28	2,18
ds s vw							
Xd Q° wu 4s ° uz v6u s uw %	169,2	171,8	164,9	177,8	178,7	184,7	187,8
X'd Q° wu 4s ° s 'w v6u s uw %	8,33	9,45	10,5	12	13,1	14,8	15,9
X''d Q° wu 4s ° t s 'w v6u s uw %	4,72	5,07	5,58	6,19	6,96	8,08	8,96
Xq b sv s w4s ° uz v6u s uw %	83,2	94,5	91	100,5	103,1	108,2	112,5
X'q b sv s w4s ° s 'w v6u s uw %	83,2	94,5	91	100,5	103,1	108,2	112,5
X''q b sv s w4s ° t s 'w v6u s uw %	16,9	18,5	19,1	18,9	17,9	17,3	16,7
X2] wv s ° w4 w w uw v6u s uw %	11	12,3	13,2	13,7	13,8	13,5	12,9
Xo l w w w uw v6u s uw %	2,79	2,59	2,69	2,48	2,38	2,28	2,18
Kcc dz u° u ° s °	0,44	0,46	0,45	0,44	0,43	0,42	0,53
T'd e s 'w ° wu s sec	0,073	0,078	0,083	0,085	0,091	0,099	0,102
T''d d t s 'w ° wu s sec	0,011	0,012	0,013	0,013	0,012	0,013	0,012
T'do ^ w u° u ° wu s sec	0,7	0,9	1,1	1,3	1,4	1,5	1,6
Ta N s w ° wu s sec	0,015	0,016	0,018	0,017	0,016	0,013	0,015

l Dn t GQH

lo R u° s ° u w s sv A	0,8	0,7	0,67	0,71	0,78	0,72	0,6
lc R u° s ° u w s x sv A	3,2	3,0	3,0	2,8	3,9	3,9	3,1
^ w sv	4						
^ w sv w 97 w5	300						
Uw6 v° s ° W	11844	12600	13548	14133	16137	19465	20239
eww z wUs 'u Ssu 4eUS %	<2	<2	<2	<2	<2	<2	<2
h s wx Q° 5eUQ0x sv ZZ6Z %	3,1 / 3	3 / 2,9	2,8 / 2,9	2,9 / 3,1	3 / 2,9	3,1 / 2,9	3,2 / 3
h s wx Q° 5eUQ0 sv ZZ6Z %	2,8 / 2,7	2,7 / 2,6	2,6 / 2,8	2 / 2,1	2,6 / 2,8	2,7 / 2,7	2,8 / 2,6

4 Dn t GQVH

f s s vw / wSR] @7.; 4 0	RP^: B 8d; P	RP^: B 9d; P	RP^: B 8; P	RP^: B 9[; P	RP^: B 8Z; P	RP^: B 9Z; P	RP^: B 9Z; P	RP^: B 9Z; P
Xd Q° wu 4s ° uz v6u s uw %	207,7	207	198,7	214,2	215,3	222,5	224,3	
X'd Q° wu 4s ° s 'w v6u s uw %	10,2	11,4	12,7	14,5	15,8	17,8	19	
X''d Q° wu 4s ° t s 'w v6u s uw %	5,8	6,11	6,72	7,45	8,38	9,73	10,7	
Xq b sv s w4s ° uz v6u s uw %	102,1	113,8	109,7	121,1	124,2	130,4	134,4	
X'q b sv s w4s ° s 'w v6u s uw %	102,1	113,8	109,7	121,1	124,2	130,4	134,4	
X''q b sv s w4s ° t s 'w v6u s uw %	20,8	22,2	23	22,8	21,5	20,8	19,9	
X2] wv s ° w4 w w uw v6u s uw %	13,5	14,8	15,9	16,6	16,7	16,2	15,5	
Xo l w w w uw v6u s uw %	2,85	2,59	2,69	2,48	2,38	2,28	2,16	
ds s vw								
Xd Q° wu 4s ° uz v6u s uw %	172,4	171,8	164,9	177,8	178,7	184,7	186,2	
X'd Q° wu 4s ° s 'w v6u s uw %	8,49	9,45	10,5	12	13,1	14,8	15,8	
X''d Q° wu 4s ° t s 'w v6u s uw %	4,81	5,07	5,58	6,19	6,96	8,08	8,88	
Xq b sv s w4s ° uz v6u s uw %	84,8	94,5	91	100,5	103,1	108,2	111,6	
X'q b sv s w4s ° s 'w v6u s uw %	84,8	94,5	91	100,5	103,1	108,2	111,6	
X''q b sv s w4s ° t s 'w v6u s uw %	17,2	18,5	19,1	18,9	17,9	17,3	16,5	
X2] wv s ° w4 w w uw v6u s uw %	11,2	12,3	13,2	13,7	13,8	13,5	12,9	
Xo l w w w uw v6u s uw %	2,85	2,59	2,69	2,48	2,38	2,28	2,16	
Kcc dz u° u ° s °	0,44	0,46	0,45	0,44	0,43	0,42	0,54	
T'd e s 'w ° wu s sec	0,073	0,078	0,083	0,085	0,091	0,099	0,102	
T''d d t s 'w ° wu s sec	0,011	0,012	0,013	0,013	0,012	0,013	0,012	
T'do ^ w u° u ° wu s sec	0,7	0,9	1,1	1,3	1,4	1,5	1,6	
Ta N s w ° wu s sec	0,015	0,016	0,018	0,017	0,016	0,013	0,015	

l Dn t GQVH

lo R u° s ° u w s sv A	0,8	0,65	0,65	0,7	0,7	0,7	0,6	
lc R u° s ° u w s x sv A	3,2	2,9	2,9	2,8	3,8	3,9	3,1	
^ w sv				4				
^ w sv w 97 w45				300				
Uw6 v° s ° W	12437	12691	13299	13968	16118	20310	20881	
eww z wV wxv s uw5su 4e15	<40	<40	<40	<40	<40	<40	<40	
h s wx Q° 5eUQ0x sv ZZ6Z] %	3,1 / 3	3 / 2,9	2,8 / 2,9	2,9 / 3,1	3 / 2,9	3,1 / 2,9	3,2 / 3	
h s wx Q° 5eUQ0 sv ZZ6Z] %	2,8 / 2,7	2,7 / 2,6	2,6 / 2,8	2 / 2,1	2,6 / 2,8	2,7 / 2,7	2,8 / 2,6	

p i Rht

[vw	: 87g =7U					: 77g =7U					: 8g =7U					: ; 7g =7U					
	79=	75=	75A=	8	88	79=	75=	75A=	8	88	79=	75=	75A=	8	88	79=	75=	75A=	8	88	
RP ^A : B 8d; P	%	89,1	91,2	92,3	92,3	92,1	88,9	91,3	92,6	92,4	92,1	88,7	91,3	92,5	92,1	91,8	88,5	91,1	92,2	91,9	91,5
RP ^A : B 9d; P	%	90,1	91,6	92,6	92,6	92,4	89,9	91,7	92,9	92,7	92,4	89,7	91,7	92,8	92,4	92,1	89,5	91,5	92,5	92,2	91,8
RP ^A : B 8f ; P	%	89,6	91,9	93,0	92,9	92,7	89,4	92,0	93,3	93,0	92,7	89,2	92,0	93,2	92,7	92,4	89,0	91,8	92,9	92,5	92,1
RP ^A : B 9[; P	%	90,1	92,3	93,4	93,3	93,1	89,9	92,4	93,7	93,4	93,1	89,7	92,4	93,6	93,1	92,8	89,5	92,2	93,3	92,9	92,5
RP ^A : B 8Z; P	%	90,2	92,7	93,8	93,5	93,3	89,9	92,7	94,0	93,7	93,4	89,7	92,7	93,9	93,4	93,1	89,5	92,5	93,6	93,2	92,8
RP ^A : B 9Z; P	%	90,1	92,5	93,4	93,4	93,2	89,9	92,6	93,7	93,5	93,2	89,7	92,6	93,6	93,2	92,9	89,5	92,4	93,3	93,0	92,6
RP ^A : B 8Z; P	%	90,3	92,4	93,5	93,5	93,3	90,1	92,5	93,8	93,6	93,3	89,9	92,5	93,7	93,3	93,0	89,7	92,3	93,4	93,1	92,8

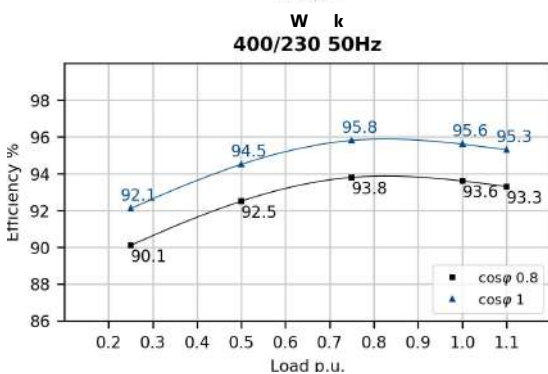
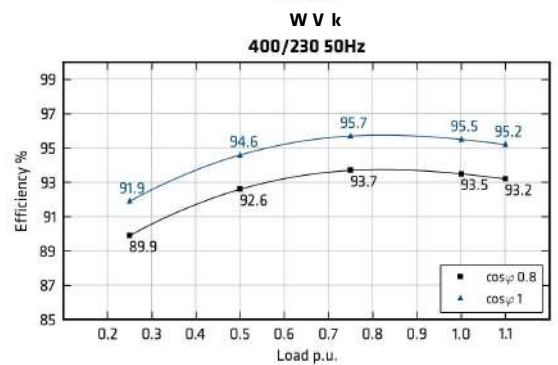
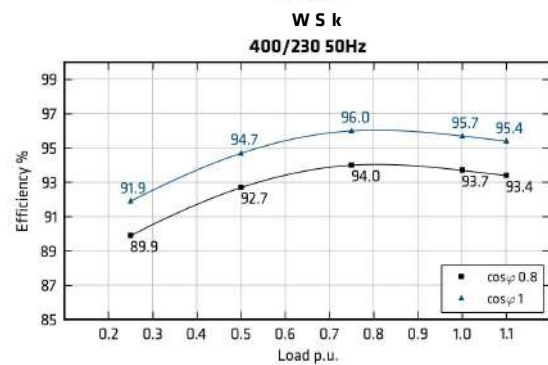
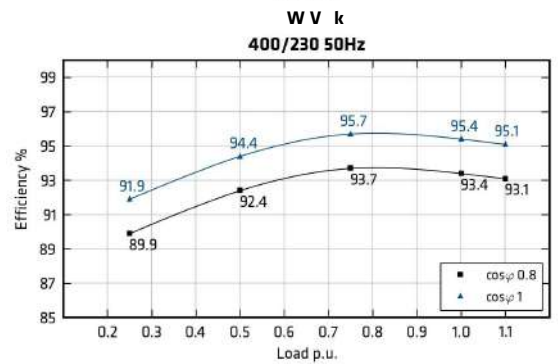
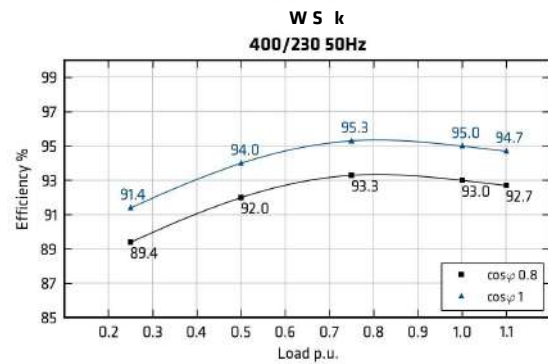
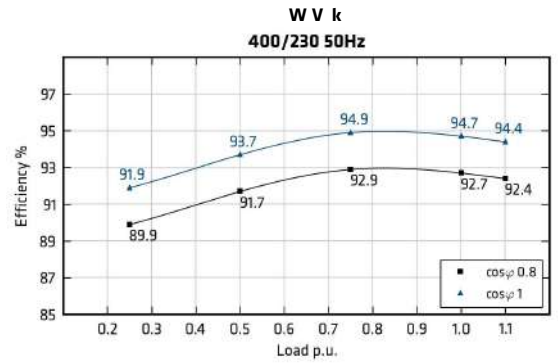
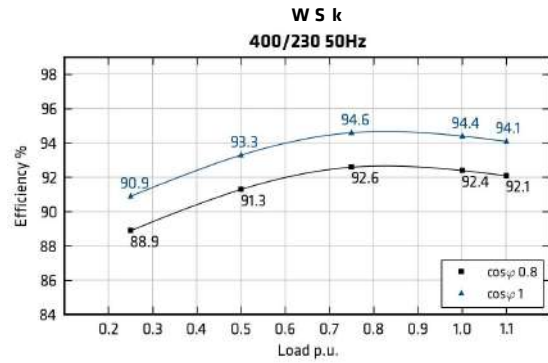

p i Sht

[vw	; 8-g @U					; 7g @U					; @g @U					; B7g @U				
	7g=	75=	75A=	8	88	7g=	75=	75A=	8	88	7g=	75=	75A=	8	88	7g=	75=	75A=	8	88
RP^: B 8d; P	%	90,1	92,0	93,0	92,7	92,4	90,1	92,1	93,2	93,0	90,1	92,2	93,4	93,3	93,2	89,9	92,3	93,6	93,4	93,2
RP^: B 9d; P	%	90,6	92,5	93,4	93,1	92,8	90,6	92,6	93,6	93,4	90,6	92,7	93,8	93,7	93,6	90,4	92,8	94,0	93,8	93,6
RP^: B 8f; P	%	90,6	93,1	93,9	93,5	93,2	90,6	93,2	94,1	94,0	93,8	90,6	93,3	94,3	94,1	90,4	93,4	94,5	94,2	94,0
RP^: B 9f; P	%	90,6	93,4	94,3	93,8	93,5	90,6	93,5	94,5	94,3	94,1	90,6	93,6	94,7	94,4	90,4	93,7	94,9	94,5	94,1
RP^: B 8Z; P	%	90,6	93,6	94,5	94,0	93,7	90,6	93,7	94,7	94,5	94,3	90,6	93,8	94,9	94,6	90,4	93,9	95,1	94,7	94,3
RP^: B 9Z; P	%	90,6	93,0	93,9	93,6	93,3	90,6	93,1	94,1	94,1	93,9	90,6	93,2	94,3	94,2	90,4	93,3	94,5	94,3	93,9
RP^: B 8Z; P	%	90,8	92,9	94,0	93,7	93,4	90,8	93,0	94,2	94,2	94,0	90,8	93,1	94,4	94,3	94,1	90,6	93,2	94,6	94,4

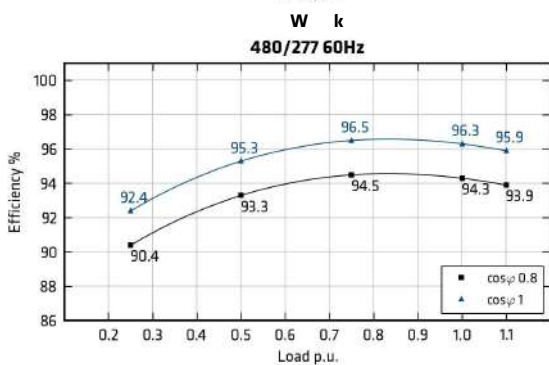
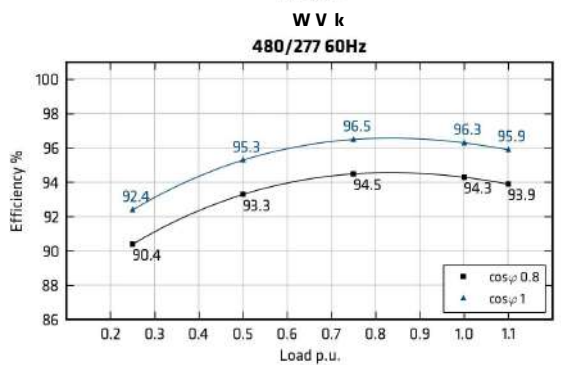
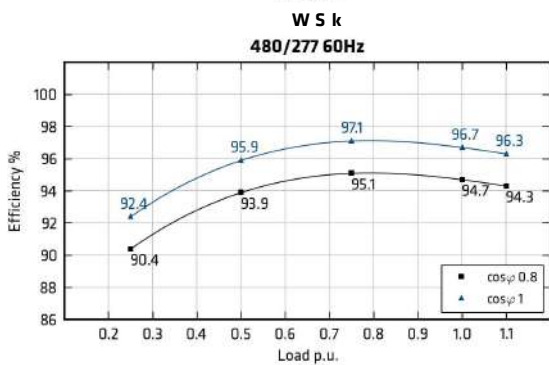
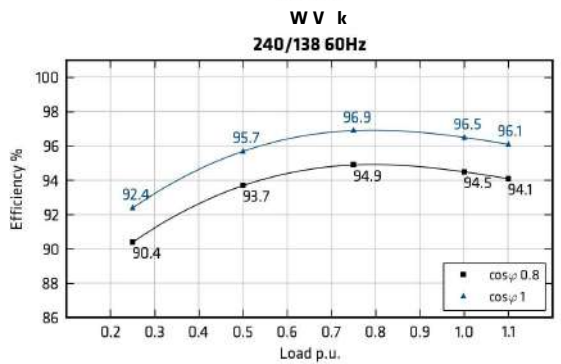
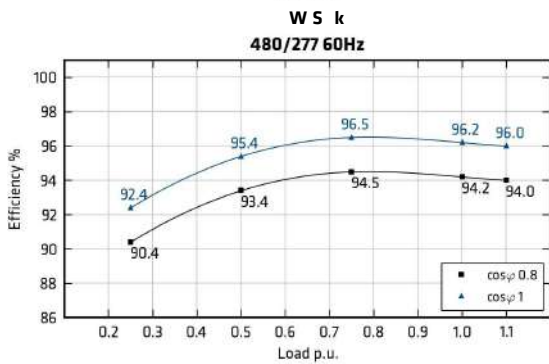
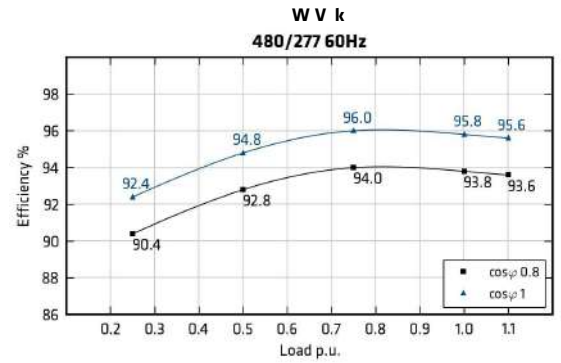
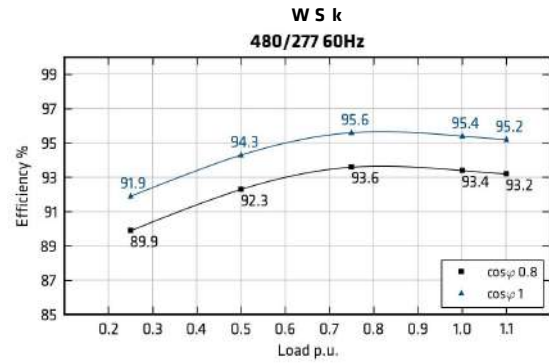

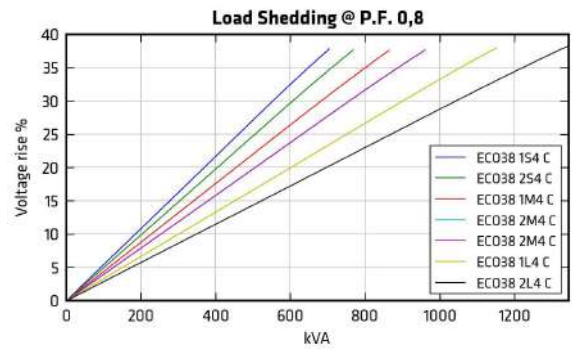
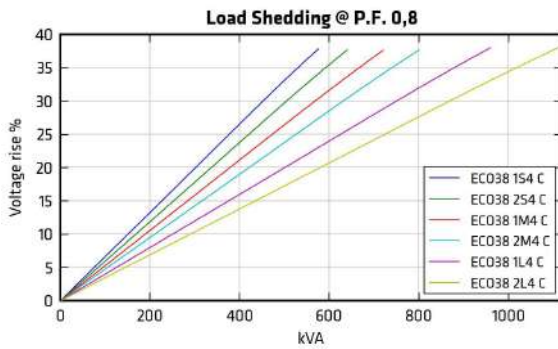
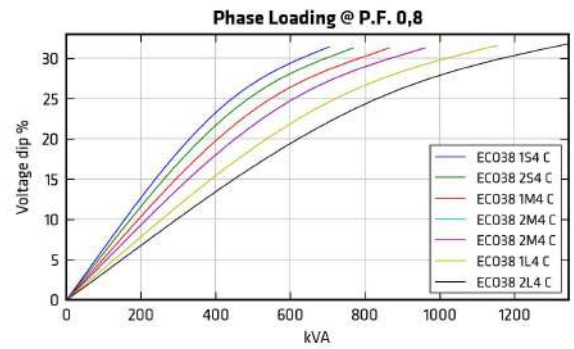
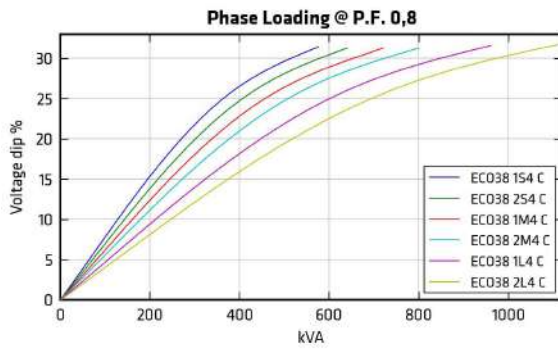
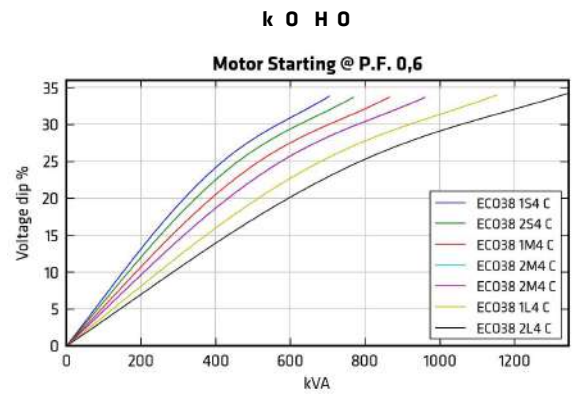
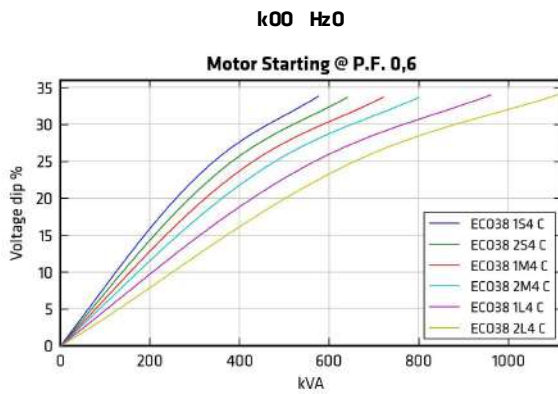

V vw usws w u w s s x u° xs w xsu syw° v'us w3 w6 w uww s x D

a w Ssu u wx'w u wu /aSPPB tw w w xsu 75@u w D

aSPPH° /Nc Pu /aS w 0679B

R s v6ezwaSPPs w xsu 75° 88C9 maSPPH° /Nc Pu /75 0679B 6ez° w6 z s zw sywxs s sy° w w s x75° w ° s w zw

w z s us tw wsv zw x75@u w'x zw sv° u 'vw w 88C9° w t'yyw /8C, z'yzw s v605

V z° w s v8s 87 gN sv° w ° s x75° w ° s w ° sywxs s 88C gN sv° w ° s x75@5

g sywu wx'w u wu /gPPD

gPPH/;776g w 0'x=7 U EgPPH/; B76g w 0'x@ U

R s v6gPPs ;8-g @ U ° 88 :B ngPPH/; B76; 8=Q96ez° w6 z s zw sywxs s sy° w w s ;8-g° w ° s w zw w z s us tw wsv

zw w xsu 75@u w'x zw sv° u 'vw w 88 :B° w t'yyw /:; z'yzw s v605

V z° w s v8s 87 gN sv° w ° s ;8-g° w ° s w ° sywxs s 88 : gN sv° w ° s ;B7g5

RHt

D

RP^ : B &d ; P

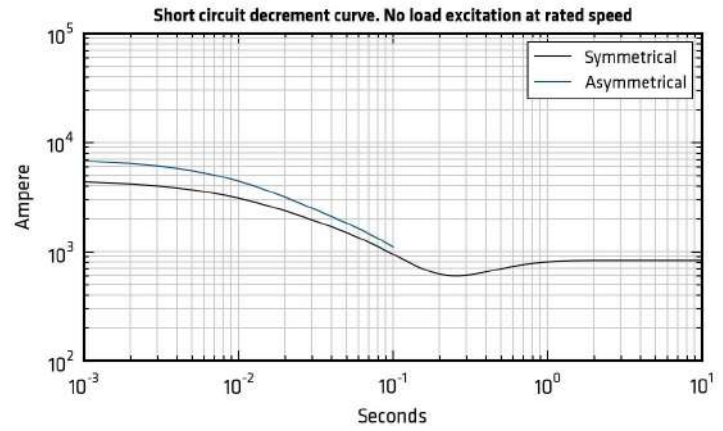

RP^ : B 9d ; P

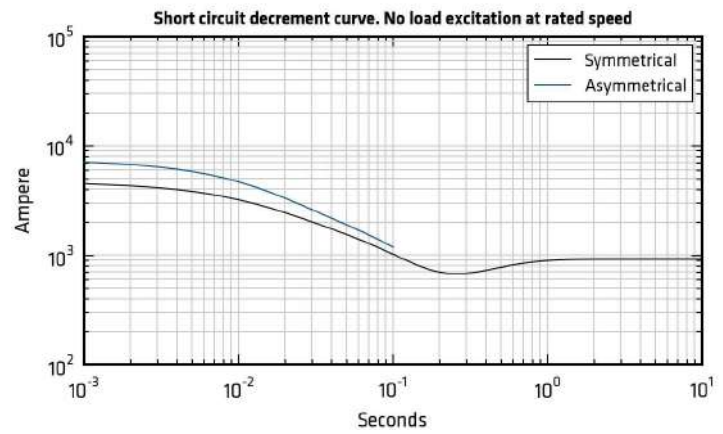

RP^ : B &l ; P

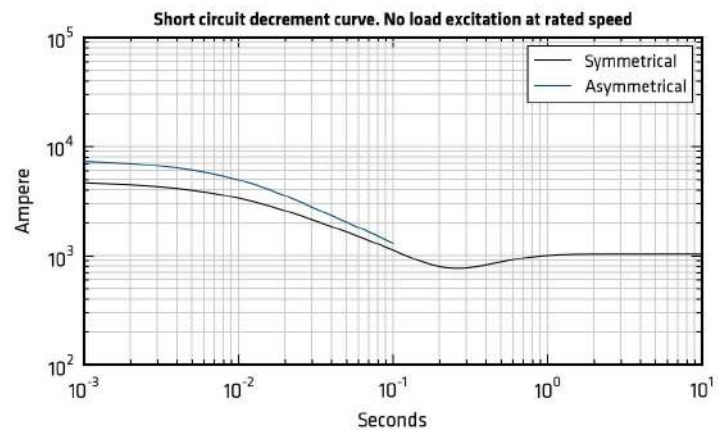

RP^ : B 9[; P

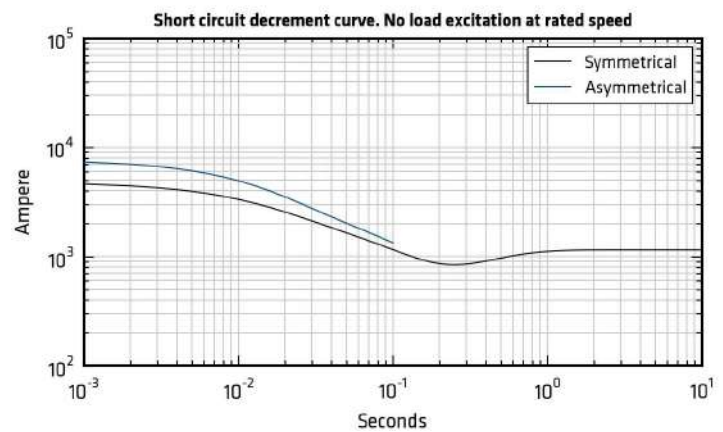

RHt

D

RP^ : B 8Z; P

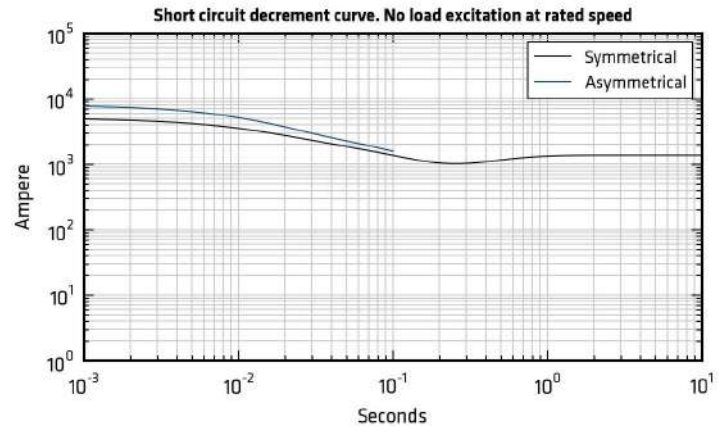

RP^ : B 9Z; P

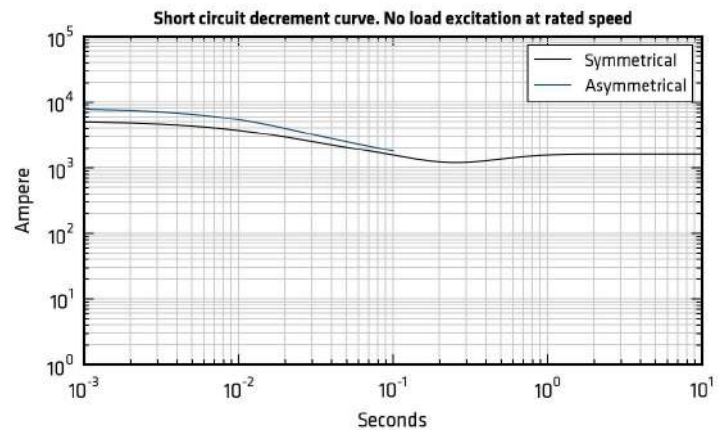

RP^ : B gZ; P

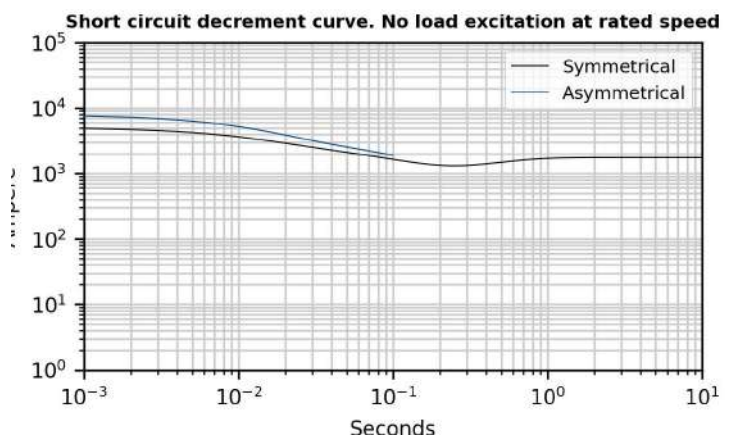

Sht

D

RP^ : B 8d ; P

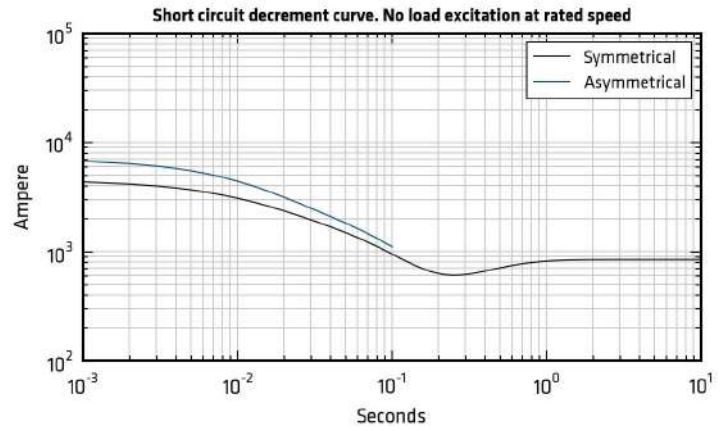

RP^ : B 9d ; P

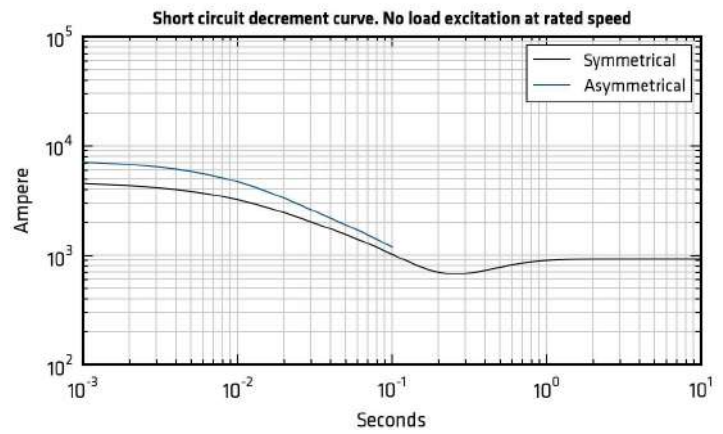

RP^ : B 8f ; P

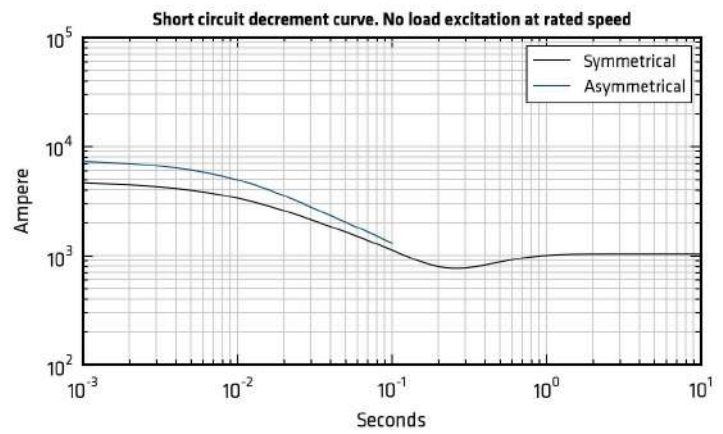

RP^ : B 9[; P

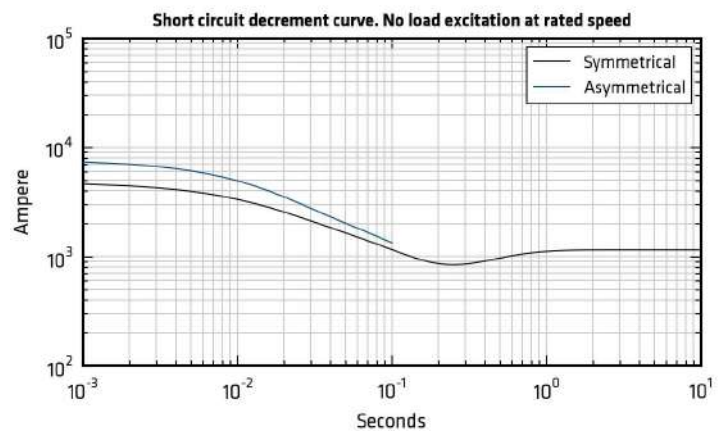

Sht

D

RP^ : B 8Z; P

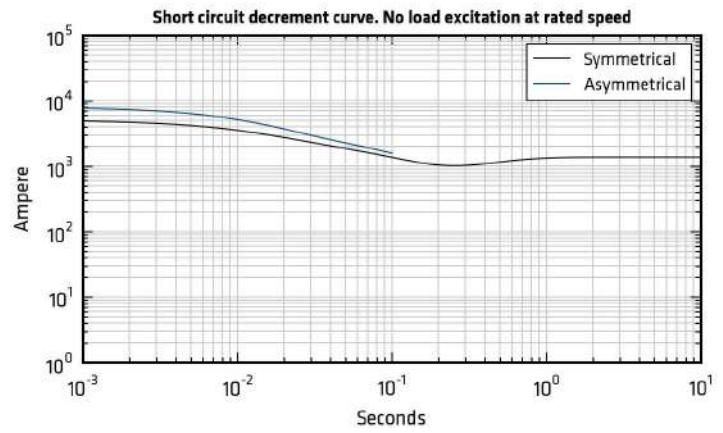

RP^ : B 9Z; P

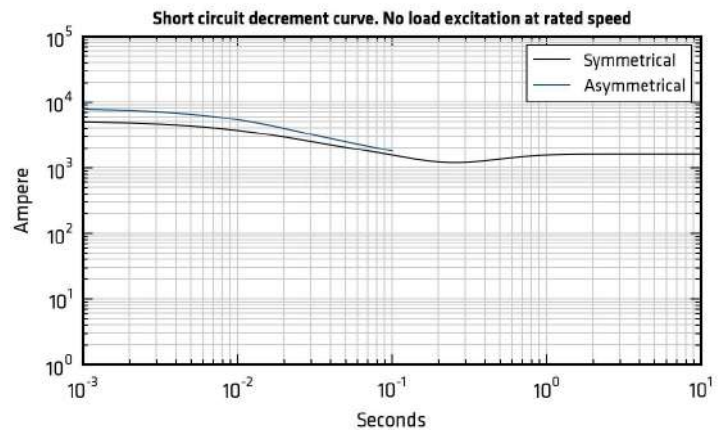

RP^ : B gZ; P

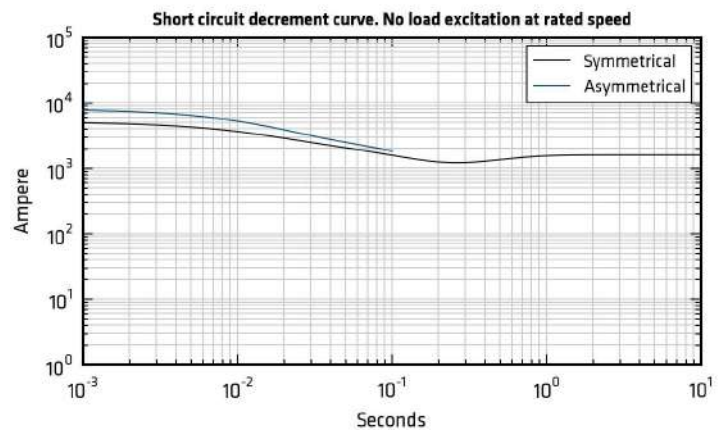

l n

Qs s	RP^: B 8d; P		RP^: B 9d; P		RP^: B 9[; P		RP^: B 9[; P		RP^: B 9Z; P		RP^: B 9Z; P		RP^: B 9Z; P	
	=7U	@U	=7U	@U	=7U	@U	=7U	@U	=7U	@U	=7U	@U	=7U	@U
Qs w usyw	P w													
d s h ° v° y c w ° s uw/97 P0	Ω	0,013	0,011	0,008	0,007	0,006	0,004	0,004						
c h ° v° y c w ° s uw/97 P0	Ω	3,905	4,133	4,449	4,887	5,604	6,78	7,383						
d s R ū w c w ° s uw/97 P0	Ω	13,47	13,47	13,47	15,28	13,47	13,47	13,47						
c R ū w c w ° s uw/97 P0	Ω	0,719	0,719	0,719	0,719	0,719	0,719	0,719						
h w y z x u w w y w w s	kg	525,0	550,0	600,0	653,0	771,0	895,0	957,0						
f t s s u w s y w ū	kN/mm	4,4	5,2	5,7	5,1	5,9	6,2	6,5						
N° x	m³/min	32,0	39,0	32,0	39,0	32,0	39,0	32,0	39,0	32,0	39,0	32,0	39,0	32,0
] ° w w w s 8 6A	dB(A)	82/69	86/73	82/69	86/73	82/69	86/73	82/69	86/73	82/69	86/73	82/69	86/73	82/69

0

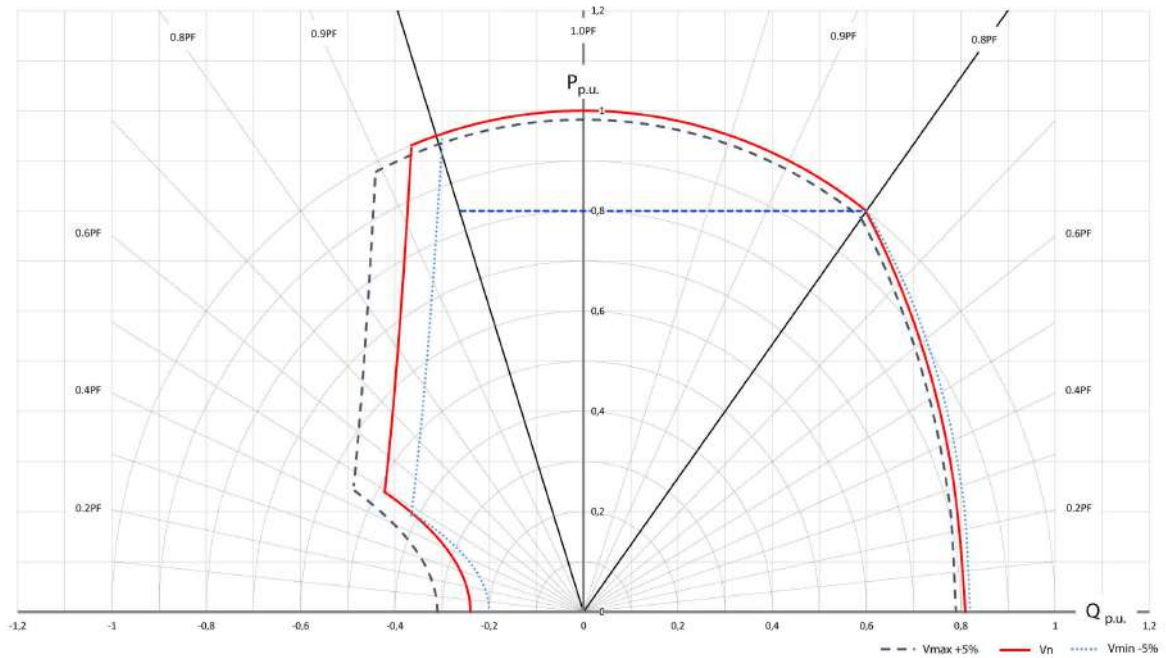

MOMENTS OF INERTIA - DOUBLE BEARING

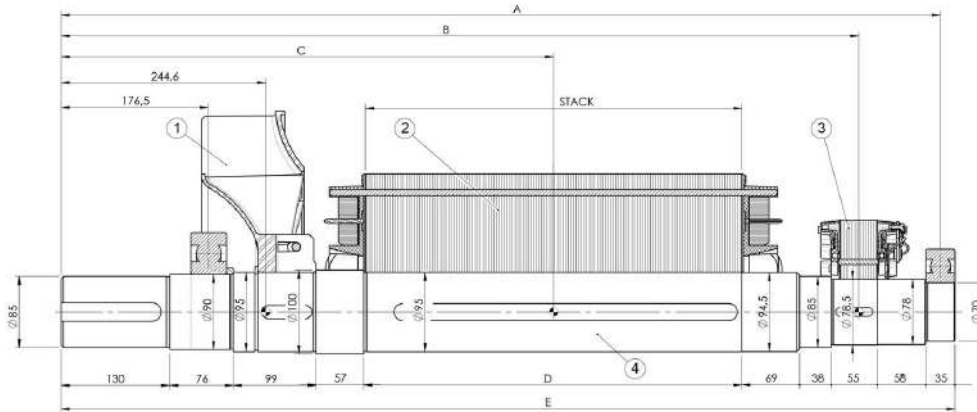

POS. COMPONENT	1 FAN		2 MAIN ROTOR		3 EXCITER ROTOR		4 SHAFT*		TOTAL	
	WEIGHT [kg]	J [kgm ²]	WEIGHT [kg]	J [kgm ²]	WEIGHT [kg]	J [kgm ²]	WEIGHT [kg]	J [kgm ²]	WEIGHT [kg]	J [kgm ²]
TYPE										
ECO38 1S / 4C	6,6	0,1633	106,2	1,4461	11,7	0,0806	40,8	0,0426	165,3	1,7326
ECO38 2S / 4C			115,9	1,5767			175,0	1,8632		
ECO38 1M / 4C			130,4	1,7724			193,4	2,0634		
ECO38 2M / 4C			150,0	2,0378			213,0	2,3287		
ECO38 1L / 4C			184,2	2,5007			256,8	2,8026		
ECO38 2L / 4C			232,9	3,1584			305,4	3,4602		
ECO38 VL / 4C			253,0	3,4336			327,8	3,7380		

TYPE	DIMENSION				
	A [mm]	B [mm]	C [mm]	D [mm]	E [mm]
ECO38 1S / 4C	811,5	714,2	479,0	212,0	829,0
ECO38 2S / 4C			469,0		
ECO38 1M / 4C	881,5	784,2	524,0	282,0	899,0
ECO38 2M / 4C			504,0		
ECO38 1L / 4C	1051,5	954,2	639,0	452,0	1069,0
ECO38 2L / 4C			589,0		
ECO38 VL / 4C	1091,5	994,2	609,0	492,0	1109,0

* Shaft mass and inertia also include rotor keys

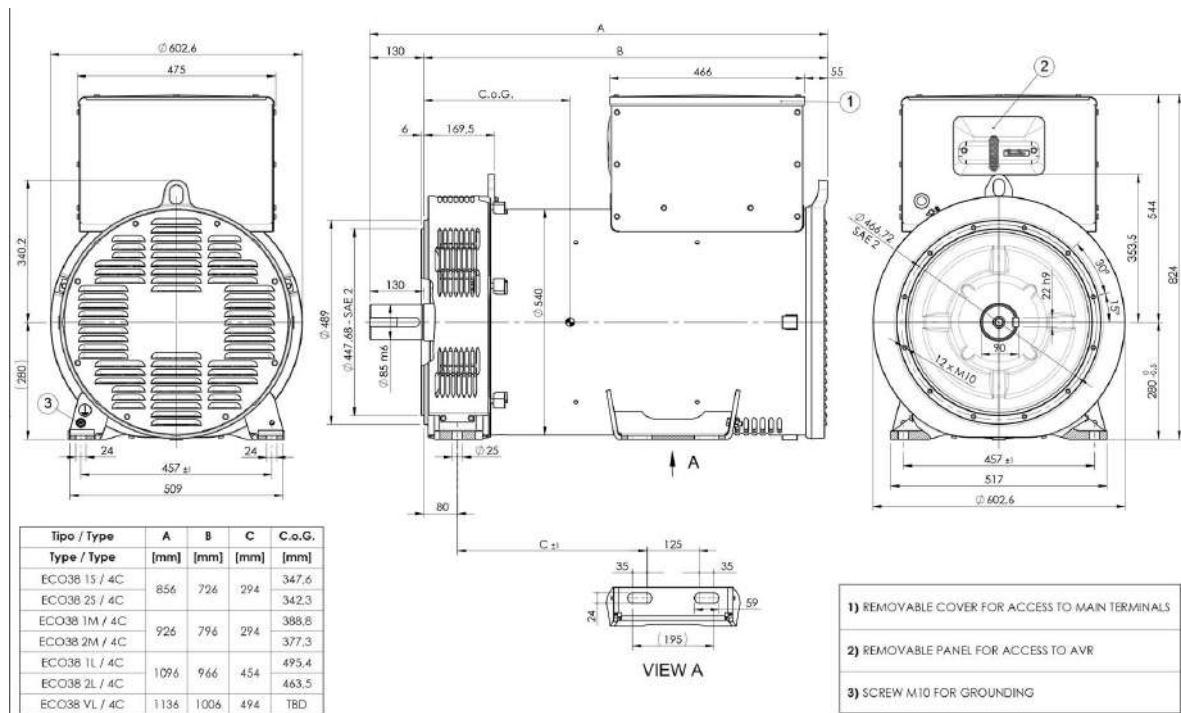

Tipo / Type	A [mm]	B [mm]	C [mm]	C.o.G. [mm]
ECO38 1S / 4C	856	724	294	347,6
ECO38 2S / 4C				342,3
ECO38 1M / 4C	926	796	294	388,8
ECO38 2M / 4C				377,3
ECO38 1L / 4C	1096	966	454	495,4
ECO38 2L / 4C				463,5
ECO38 VL / 4C	1136	1006	494	TBD

- 1) REMOVABLE COVER FOR ACCESS TO MAIN TERMINALS
- 2) REMOVABLE PANEL FOR ACCESS TO AVR
- 3) SCREW M10 FOR GROUNDING

MOMENTS OF INERTIA - SINGLE BEARING

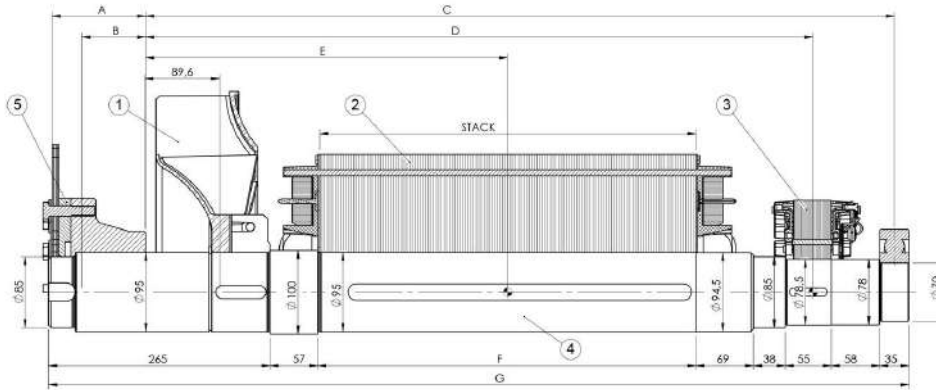

* Shaft mass and inertia also include rotor keys

POS.	1		2		3		4		TOTAL	
	WEIGHT [kg]	J [kgm ²]	WEIGHT [kg]	J [kgm ²]	WEIGHT [kg]	J [kgm ²]	WEIGHT [kg]	J [kgm ²]	WEIGHT [kg]	J [kgm ²]
COMPONENT	FAN		MAIN ROTOR		EXCITER ROTOR		SHAFT*			
TYPE										
ECO38 1S / 4C			106,2	1,4461			40,2	0,0434	164,8	1,7333
ECO38 2S / 4C			115,9	1,5767					174,5	1,8639
ECO38 1M / 4C			130,4	1,7724					192,9	2,0641
ECO38 2M / 4C	6,6	0,1633	150,0	2,0378	11,7	0,0806	44,1	0,0479	212,5	2,3295
ECO38 1L / 4C			184,2	2,5007					256,2	2,8033
ECO38 2L / 4C			232,9	3,1584					304,9	3,4610
ECO38 VL / 4C			253,0	3,4336					55,9	0,0613

SAE N.	5 SHAFTS COUPLING FLEX PLATE			
	A	B	WEIGHT [kg]	J [kgm ²]
11,5	110,6	75,7	19,3	0,1793
14,0	96,4	74,1	22,4	0,3630

TYPE	DIMENSION				
	C [mm]	D [mm]	E [mm]	F [mm]	G [mm]
ECO38 1S / 4C			324,0		
ECO38 2S / 4C	656,5	559,2	314,0	212,0	789,0
ECO38 1M / 4C			369,0		
ECO38 2M / 4C	726,5	629,2	349,0	282,0	859,0
ECO38 1L / 4C			484,0	452,0	1029,0
ECO38 2L / 4C	896,5	799,2	434,0		
ECO38 VL / 4C	936,5	839,2	454,0	492,0	1069,0

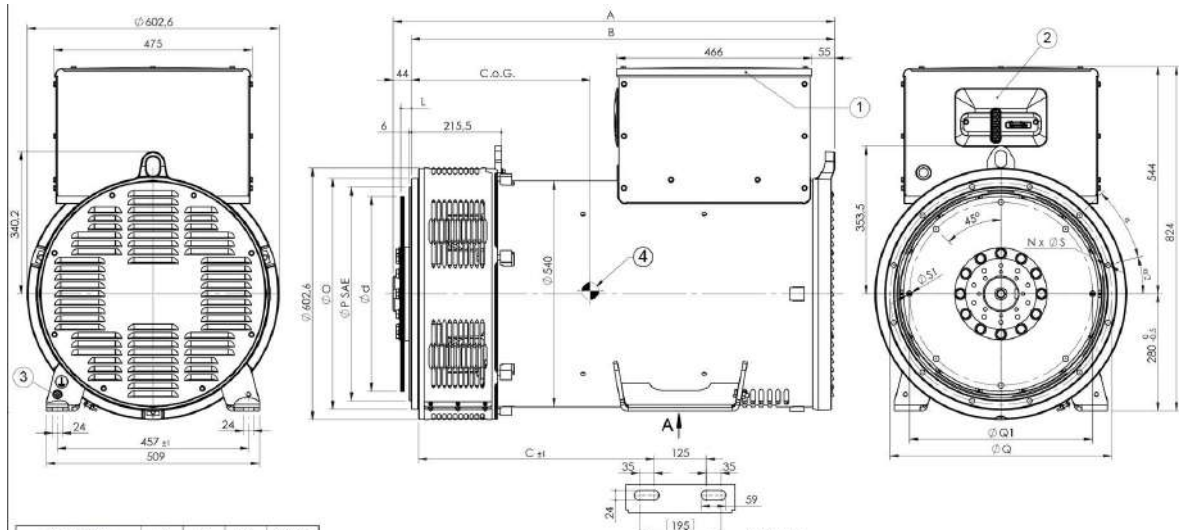

Tipo / Type	A [mm]	B [mm]	C [mm]	C.o.G. [mm]
ECO38 1S / 4C	816	772	420	388,7
ECO38 2S / 4C				383,6
ECO38 1M / 4C	886	842	420	430,5
ECO38 2M / 4C				419,4
ECO38 1L / 4C	1056	1012	580	538,1
ECO38 2L / 4C				506,7
ECO38 VL / 4C	1096	1052	620	527,0

SAE N.	Flangia / Flange				
	O	P	Q	S	N
3	451	409,58	428,62	12	12
2	489	447,68	466,72	12	12
1	552	511,18	530,22	12	12
1/2	648	584,20	619,12	14	12
0	711	647,70	679,45	14	16

SAE N.	Giunti a dischi / Disc coupling			
	d	L	Q1	S1
11 1/2	352,42	39,6	333,37	11
14	466,72	25,4	438,15	13,5

- 1) REMOVABLE COVER FOR ACCESS TO MAIN TERMINALS
- 2) REMOVABLE PANEL FOR ACCESS TO AVR
- 3) SCREW M10 FOR GROUNDING
- 4) CENTER OF GRAVITY IN CONFIGURATION SAE 1 FLYWHEEL 14

pn PV Q n



Lined writing area with 20 horizontal lines.

Mecc Alte SpA (HQ)

Via Roma
20 - 36051 Creazzo
Vicenza - ITALY
T: +39 0444 396111
F: +39 0444 396166
E: info@meccalte.it
aftersales@meccalte.it

Mecc Alte Portable

Via Roma
20 - 36051 Creazzo
Vicenza - ITALY
T: +39 0444 396111
F: +39 0444 396166
E: info@meccalte.it
aftersales@meccalte.it

Mecc Alte Power Products srl

Via Melaro
Z - 36075 Montecchio
Maggiore (VI) - ITALY
T: +39 0444 1831295
F: +39 0444 1831306
E: info@meccalte.it
aftersales@meccalte.it

Zanardi Alternatori srl

Via Dei Laghi
48/B - 36077 Altavilla
Vicenza - ITALY
T: +39 0444 370799
F: +39 0444 370330
E: info@zanardialternatori.it

United Kingdom

Mecc Alte U.K. LTD
6 Lands' End Way
Oakham
Rutland LE15 6RF
T: +44 (0) 1572 771160
F: +44 (0) 1572 771161
E: info@meccalte.co.uk
aftersales@meccalte.co.uk

Spain

Mecc Alte España S.A.
C/ Rio Taibilla, 2
Polig. Ind. Los Valeros
03178 Benijofar (Alicante)
T: +34 (0) 96 6702152
F: +34 (0) 96 6700103
E: info@meccalte.es
aftersales@meccalte.es

China

Mecc Alte Alternator Haimen LTD
755 Nanghai East Rd
Jiangsu HEDZ 226100 PRC
T: +86 (0) 513 82325758
F: +86 (0) 513 82325768
E: info@meccalte.cn
aftersales@meccalte.cn

India

Mecc Alte India PVT LTD
Plot NO: 1, Sanaswadi
Talegaon
Dhamdhare Road Taluka:
Shirur, District:
Pune - 412208
Maharashtra, India
T: +91 2137 619600
F: +91 2137 619699
E: info@meccalte.in
aftersales@meccalte.in

U.S.A. and Canada

Mecc Alte Inc.
1229 Adams Drive
McHenry, IL, 60051
T: +1 815 344 0530
F: +1 815 344 0535
E: info@meccalte.us
aftersales@meccalte.us

Germany

Mecc Alte Generatoren GmbH
Ensener Weg 21
D-51149 Köln
T: +49 (0) 2203 503810
F: +49 (0) 2203 503796
E: info@meccalte.de
aftersales@meccalte.de

Australia

Mecc Alte Alternators PTY LTD
10 Duncan Road, PO Box 1046
Dry Creek, 5094, South
Australia
T: +61 (0) 8 8349 8422
F: +61 (0) 8 8349 8455
E: info@meccalte.com.au
aftersales@meccalte.com.au

France

Mecc Alte International S.A.
Z.E.La Gagnerie
16330 ST.Amant de Boixe
T: +33 (0) 545 397562
F: +33 (0) 545 398820
E: info@meccalte.fr
aftersales@meccalte.fr

Far East

Mecc Alte (F.E.) PTE LTD
19 Kian Teck Drive
Singapore 628836
T: +65 62 657122
F: +65 62 653991
E: info@meccalte.com.sg
aftersales@meccalte.com.sg



www.meccalte.com