



Totally Focused. Totally Independent.

## Technical Guide

RP<sup>^</sup> : B ; P

**G-TYPE**



The world's largest  
independent producer of  
alternators 1 – 5,000kVA







## Standards

Alternators are designed and produced within an ISO 9001 environment. The entire series is manufactured according to, and complies with, the most common specifications such as CEI 2-3, IEC 34-1, EN 60034-1, VDE 0530, BS 4999-5000, NF 51.111, NEMA MG 1-2011, ISO 8528-3. They also comply with other specific standards such as UL1446, UL 1004/4 and /B and CAN/CSA-C22.2 No14-95-No100-95.

## Windings and Performances

All windings are 2/3rds pitch to eliminate triplen harmonics within the voltage waveform and to avoid excessive neutral currents in certain parallel operating conditions. A fully interconnected aluminium or copper damper cage is supplied on the rotor of all models (excluding the ECP3 series).

- ▶ 12 wire reconnectable:  
50Hz – 380V to 440V and 220/110V to 240/120V (de-rates may apply at certain voltages)  
60Hz – 380V to 480V and 220/110V to 240/120V (de-rates may apply at certain voltages)
- ▶ 6 wire reconnectable:  
50Hz – 380V to 440V and 220V to 240V (de-rates may apply at certain voltages)  
60Hz – 380V to 480V and 220V to 240V (de-rates may apply at certain voltages)

Winding Configurations	Standard		Special (dedicated)			
	12 wire Reconnectable	6 wire Reconnectable	380V and 600V 60Hz	690V 50/60Hz	220-240V 1ph 50Hz	220-240V 1ph 60Hz
ECP3 to ECO38	Std	Option	Option	Option	Option	Option
ECO40	Std	Option	Option	Option	Option (to ECO40)	Option (to ECO40)
Insulation materials	Class H	Class H	Class H	Class H	Class H	Class H
High efficiency	Std	Std	Std	Std	Std	Std
High motor starting	>300%	>300%	>300%	>300%	>300%	>300%
THD (Total Harmonic Distortion)	Typically <3.5% full load L-L	Typically <3.0% full load L-L	Typically <3.5% full load L-L	Typically <3.5% full load L-L	Typically <4.5% full load L-N	Typically <4.5% full load L-N
Interference suppression	VDE 0875 G/N/K, EN61000-6-3, EN61000-6-2, others available on request					

## Winding Protection

There are various degrees of protection for the windings following the standard impregnation process, as can be seen here. The TOTAL+ epoxy black coating is recommended for arduous applications.

Winding Protection:	STANDARD	STANDARD+	GREY	GREY+	TOTAL+
ECP3	Std	Option	Option	Option	Option
ECP28 and ECP32	-	Std	Option	Option	Option
NPE32, ECP34 to ECO40	-	-	Std	Option	Option



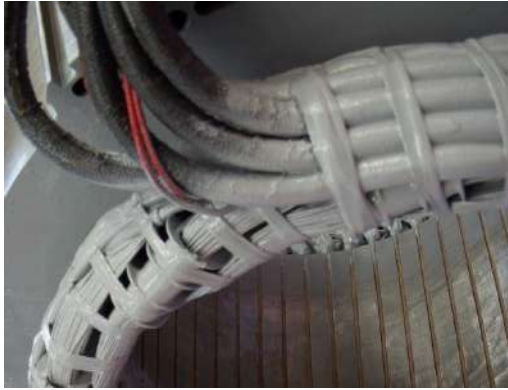

Grey treatment (marinization) on the left, TOTAL+ treatment shown on the right. The EG43 grey varnish, is a high temperature insulating enamel that forms a tough and flexible film, with excellent moisture and chemical protection. It is water and oil proof, and also protects windings from abrasion. It is applied spraying an over coating layer over the impregnated winding, or dipping the stator in a varnish barrel for superior treatments

The TOTAL+ is a protection system that makes Mecc Alte special. It is the ultimate winding treatment that offers truly superior performances when the environment is really harsh, or the application very demanding. The TOTAL+ is also extremely resistant to the particle abrasion as it adsorbs the impacts.

## Protection for Environment

In addition to protection on the windings themselves, the alternators can have increased degree of protection. Standard level is IP23 but the following solutions are also available: IP23 DP with inlet filters, IP23 with only terminal box in IP45, IP43 and IP45. Derates may be applied.

Info: [https://www.meccalte.com/downloads/MA0605\\_Bulletin\\_IP.pdf](https://www.meccalte.com/downloads/MA0605_Bulletin_IP.pdf)



## Construction

The robust mechanical structure withstands up to 5G in any direction and 9G vertically and its design permits easy access to the connections and components during routine maintenance check-ups. The mechanical design has used the most advanced FEM techniques. The materials used are: FEP12 steel for the frame, C45 steel for the shaft and cast iron or aluminum pressure die cast for the end-brackets: fans are aluminum die casted either nylon fiber glass loaded, UL compliant materials. Rotors are dynamically balanced according grades 6.3 (up to series 32) or 2.5 (from series 34 onwards) of ISO 1940-1.

## Terminals and Terminal Box

Easy access to regulators is possible due to a new AVR panel. Terminal boards have been redesigned into a special L configuration, specifically to ease customer connections; with this kind of terminal board it is possible to place a second terminal board in order to get 12 available terminals. Current transformers are available as an option on series ECO38 with single or dual output.

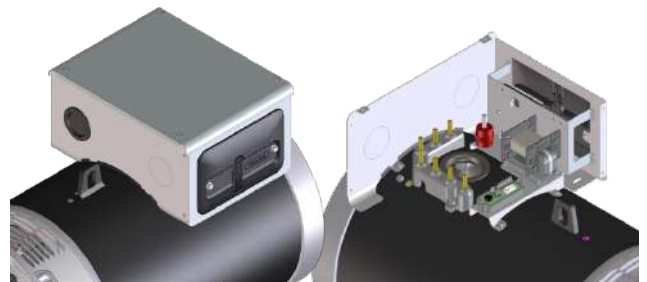



## Excitation and Regulation Systems

All ECP/ECO series have MAUX auxiliary winding to power the digital regulator. Both DSR and the DER1 are available to connect to PC through the DxR2 USB interface and DxR TERMINAL software to interrogate/download alarms & settings for analysis or for cloning other regulators. DER2 has got an integrated USB connection and can be connected to the PC without any optional connection boards. More settings such as LAMS, digital RAM based synchronous external control and soft start are obtainable through the DxR connection. Simple analogue potentiometers are available for the more usual adjustments.

Excitation Systems	DSR	DER1	DER2
ECP3 to ECO38	Std	Option	Option
ECO40	-	Std	Option
Parallel Operation	✓	✓	✓
Mains Parallel	✓	✓	✓
3 Phase Sensing (rms)	-	✓	✓
Accuracy	+/-1%	+/-0.5%	+/-0.5%
Remote Voltage Control	✓	✓	✓
Alarm Log	✓	✓	✓
Analogue and Digital Configurable	✓	✓	✓
LAMS (Load Acceptance V/f)	✓	✓	✓
APD (Active Protection Output)	✓	✓	✓
Soft Start	✓	✓	✓
High dynamic response	-	-	✓
USB connection without external boards	-	-	✓

For a given motor start duty a smaller machine may be selected – also enhanced by low sub-transient reactance values for non-linear loads. The whole range is capable of >300% sustained short circuit current for up to 20 seconds.

## Optional PMG

The Mecc Alte PMG is available on ECP28, ECP32, ECP34 and ECO38 as factory-fitted option; alternatively, only the predisposition for the retrofit, for subsequent assembly, is available on option. On series ECO40 is available as a factory-fitted or retro-fitted options.

The complete AVR range is fully compatible with both MAUX and PMG systems; this minimises spare parts management and flexibility of stock as one AVR suits all applications.

The PMG is delivering the same amount of kVA available with the MAUX.





## Dew Heater

Our whole range can be fitted with anti-condensation heaters of adequate power sized to alternator kVA. Voltage for heaters must be specified when ordering. New cylindrical cartridge style heaters are available on request and it can be retrofitted.

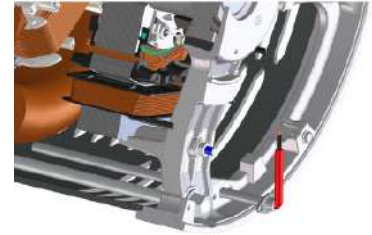

## Accessories

Additional optionals can be fit on our alternator series, such as PTC thermistors or PT100 both on windings and bearings, dew heaters, high and low profile of terminal boxes (on most series), parallel devices (standard from ECO38), current and voltage transformers, air filters, IP43 and IP45 protections and many others.

For more info visit: <https://www.meccalte.com/en/products/alternators/accessories/c-type-accessories>

## Deration coefficients

Altitude (meters)	Ambient temperature (Celsius)					
	25	40	45	50	55	60
$\leq 1000$	1.07	1	0.96	0.93	0.91	0.89
$> 1000 \leq 1500$	1.01	0.96	0.92	0.89	0.87	0.84
$> 1500 \leq 2000$	0.96	0.91	0.87	0.84	0.83	0.79
$> 2000 \leq 3000$	0.9	0.85	0.81	0.78	0.76	0.73

## Notes on short circuit curves

The indicated coefficients have to be used to correct the three phase short circuit curves values as a function of the rated voltage.

The indicated coefficient have to be used to correct the three phase short circuit curves values as a function of the type of short circuit voltage.

50 Hz		60 Hz	
Voltage	Factor	Voltage	Factor
380	0.93X	415	0.85X
400	1X	440	0.90X
415	1.04X	460	0.95X
440	1.10X	480	1X

	3 phase	2 phase L-L	1 phase L-N
<i>Instantaneous</i>	1X	0.87X	1.30X
<i>Minimum</i>	1X	1.80X	3.20X
<i>Sustained</i>	1X	1.50X	2.50X
<i>Max Duration</i>	20 sec.	10 sec.	4 sec.

All the curves are shown for series or parallel star connection at 400V 50 Hz or 480V 60 Hz. If the unit is reconnected from series to parallel star, the additional coefficient is 2X. From series star to series delta, it is 1.72X. From series star to parallel delta, it is 3.44X.



S

a w t w	;	V s ° u s	U
az s w t w	:	a w u ° u s	∅ 9:
] t w x ° w	⊗	] Q R O w s ° y w	@ & 9 c d
R w u °	O z w	Q R O w s ° y w	@ ⊗ 9 c d
c w y s w	Q d c	[ s ° ^ w w w	99=7
h ° v ° y ° u z	96:	N ° v w	7 4 8 / 7 7
P v w s y w w w w u w	e 7; 7=d:	O s s u ° y	∅ ^ 8 c; 7 4 8

RHt

gN6 h Mew 5c ° w6N t°w P479 aS																			
deN] Q0k48@ 69A				deN] Q0k48-76; 7				U48B=6; 7				S487=6; 7				O4B76; 7			
dw°w d s k	: B7g : 77g : 8-g : : 7g	: B7g : 77g : 8-g : : 7g	: B7g : 77g : 8-g : : 7g	: B7g : 77g : 8-g : : 7g	: B7g : 77g : 8-g : : 7g	: B7g : 77g : 8-g : : 7g	: B7g : 77g : 8-g : : 7g	: B7g : 77g : 8-g : : 7g	: B7g : 77g : 8-g : : 7g	: B7g : 77g : 8-g : : 7g	: B7g : 77g : 8-g : : 7g	: B7g : 77g : 8-g : : 7g	: B7g : 77g : 8-g : : 7g	: B7g : 77g : 8-g : : 7g	: B7g : 77g : 8-g : : 7g	: B7g : 77g : 8-g : : 7g	: B7g : 77g : 8-g : : 7g	: B7g : 77g : 8-g : : 7g	: B7g : 77g : 8-g : : 7g
as s w d s k k	8C7g 977g 97Bg 997g	8C7g 977g 97Bg 997g	8C7g 977g 97Bg 997g	8C7g 977g 97Bg 997g	8C7g 977g 97Bg 997g	8C7g 977g 97Bg 997g	8C7g 977g 97Bg 997g	8C7g 977g 97Bg 997g	8C7g 977g 97Bg 997g	8C7g 977g 97Bg 997g	8C7g 977g 97Bg 997g	8C7g 977g 97Bg 997g	8C7g 977g 97Bg 997g	8C7g 977g 97Bg 997g	8C7g 977g 97Bg 997g	8C7g 977g 97Bg 997g	8C7g 977g 97Bg 997g	8C7g 977g 97Bg 997g	8C7g 977g 97Bg 997g
dw°w Qw s Δ	997g 9: 7g 9: 7g 9=: g	997g 9: 7g 9: 7g 9=: g	997g 9: 7g 9: 7g 9=: g	997g 9: 7g 9: 7g 9=: g	997g 9: 7g 9: 7g 9=: g	997g 9: 7g 9: 7g 9=: g	997g 9: 7g 9: 7g 9=: g	997g 9: 7g 9: 7g 9=: g	997g 9: 7g 9: 7g 9=: g	997g 9: 7g 9: 7g 9=: g	997g 9: 7g 9: 7g 9=: g	997g 9: 7g 9: 7g 9=: g	997g 9: 7g 9: 7g 9=: g	997g 9: 7g 9: 7g 9=: g	997g 9: 7g 9: 7g 9=: g	997g 9: 7g 9: 7g 9=: g	997g 9: 7g 9: 7g 9=: g	997g 9: 7g 9: 7g 9=: g	997g 9: 7g 9: 7g 9=: g
as s w Qw s ΔΔ	887g 88-g 887g 88/Ag	887g 88-g 887g 88/Ag	887g 88-g 887g 88/Ag	887g 88-g 887g 88/Ag	887g 88-g 887g 88/Ag	887g 88-g 887g 88/Ag	887g 88-g 887g 88/Ag	887g 88-g 887g 88/Ag	887g 88-g 887g 88/Ag	887g 88-g 887g 88/Ag	887g 88-g 887g 88/Ag	887g 88-g 887g 88/Ag	887g 88-g 887g 88/Ag	887g 88-g 887g 88/Ag	887g 88-g 887g 88/Ag	887g 88-g 887g 88/Ag	887g 88-g 887g 88/Ag	887g 88-g 887g 88/Ag	887g 88-g 887g 88/Ag
W S k	196 <b>196</b> 196 180	188 <b>188</b> 188 173	180 <b>180</b> 180 165	170 <b>170</b> 170 155	144 <b>144</b> 144 132	136 <b>136</b> 136 124	115 <b>115</b> 115 106	106											
W V k	157 <b>157</b> 157 144	150 <b>150</b> 150 138	144 <b>144</b> 144 132	136 <b>136</b> 136 124	115 <b>115</b> 115 106	106													
W S k	220 <b>220</b> 220 209	211 <b>211</b> 211 200	200 <b>200</b> 200 190	185 <b>185</b> 185 175	160 <b>160</b> 160 152	152													
W V k	176 <b>176</b> 176 167	169 <b>169</b> 169 160	160 <b>160</b> 160 152	148 <b>148</b> 148 140	128 <b>128</b> 128 122	122													
W S k	250 <b>250</b> 250 234	237 <b>237</b> 237 221	225 <b>225</b> 225 210	207 <b>207</b> 207 190	180 <b>180</b> 180 168	168													
W V k	200 <b>200</b> 200 187	190 <b>190</b> 190 177	180 <b>180</b> 180 168	166 <b>166</b> 166 152	144 <b>144</b> 144 134	134													
W S k	275 <b>275</b> 275 253	264 <b>264</b> 264 243	250 <b>250</b> 250 230	230 <b>230</b> 230 215	200 <b>200</b> 200 184	184													
W V k	220 <b>220</b> 220 202	211 <b>211</b> 211 194	200 <b>200</b> 200 184	184 <b>184</b> 184 172	160 <b>160</b> 160 147	147													
W S k	330 <b>330</b> 330 319	315 <b>315</b> 315 305	300 <b>300</b> 300 290	275 <b>275</b> 275 265	240 <b>240</b> 240 232	232													
W V k	264 <b>264</b> 264 255	252 <b>252</b> 252 244	240 <b>240</b> 240 232	220 <b>220</b> 220 212	192 <b>192</b> 192 186	186													
W S k	370 <b>370</b> 370 360	360 <b>360</b> 360 350	350 <b>350</b> 350 340	320 <b>320</b> 320 310	280 <b>280</b> 280 272	272													
W V k	296 <b>296</b> 296 288	288 <b>288</b> 288 280	280 <b>280</b> 280 272	256 <b>256</b> 256 248	224 <b>224</b> 224 218	218													
W S k	380 <b>400</b> 400 370	370 <b>380</b> 380 360	360 <b>370</b> 370 350	329 <b>338</b> 338 319	288 <b>296</b> 296 280	280													
W V k	304 <b>320</b> 320 296	296 <b>304</b> 304 288	288 <b>296</b> 296 280	263 <b>270</b> 270 255	230 <b>237</b> 237 224	224													

SHt

gN6 h Mew 5c ° w6N t°w P479 aS																			
deN] Q0k48@ 69A				deN] Q0k48-76; 7				U48B=6; 7				S487=6; 7				O4B76; 7			
dw°w d s k	: 8-g : : 7g : @g : B7g	: 8-g : : 7g : @g : B7g	: 8-g : : 7g : @g : B7g	: 8-g : : 7g : @g : B7g	: 8-g : : 7g : @g : B7g	: 8-g : : 7g : @g : B7g	: 8-g : : 7g : @g : B7g	: 8-g : : 7g : @g : B7g	: 8-g : : 7g : @g : B7g	: 8-g : : 7g : @g : B7g	: 8-g : : 7g : @g : B7g	: 8-g : : 7g : @g : B7g	: 8-g : : 7g : @g : B7g	: 8-g : : 7g : @g : B7g	: 8-g : : 7g : @g : B7g	: 8-g : : 7g : @g : B7g	: 8-g : : 7g : @g : B7g	: 8-g : : 7g : @g : B7g	: 8-g : : 7g : @g : B7g
as s w d s k k	97Bg 997g 9: 7g 9: 7g	97Bg 997g 9: 7g 9: 7g	97Bg 997g 9: 7g 9: 7g	97Bg 997g 9: 7g 9: 7g	97Bg 997g 9: 7g 9: 7g	97Bg 997g 9: 7g 9: 7g	97Bg 997g 9: 7g 9: 7g	97Bg 997g 9: 7g 9: 7g	97Bg 997g 9: 7g 9: 7g	97Bg 997g 9: 7g 9: 7g	97Bg 997g 9: 7g 9: 7g	97Bg 997g 9: 7g 9: 7g	97Bg 997g 9: 7g 9: 7g	97Bg 997g 9: 7g 9: 7g	97Bg 997g 9: 7g 9: 7g	97Bg 997g 9: 7g 9: 7g	97Bg 997g 9: 7g 9: 7g	97Bg 997g 9: 7g 9: 7g	97Bg 997g 9: 7g 9: 7g
dw°w Qw s Δ	9: 7g 9=: g 9@-g 9A/g	9: 7g 9=: g 9@-g 9A/g	9: 7g 9=: g 9@-g 9A/g	9: 7g 9=: g 9@-g 9A/g	9: 7g 9=: g 9@-g 9A/g	9: 7g 9=: g 9@-g 9A/g	9: 7g 9=: g 9@-g 9A/g	9: 7g 9=: g 9@-g 9A/g	9: 7g 9=: g 9@-g 9A/g	9: 7g 9=: g 9@-g 9A/g	9: 7g 9=: g 9@-g 9A/g	9: 7g 9=: g 9@-g 9A/g	9: 7g 9=: g 9@-g 9A/g	9: 7g 9=: g 9@-g 9A/g	9: 7g 9=: g 9@-g 9A/g	9: 7g 9=: g 9@-g 9A/g	9: 7g 9=: g 9@-g 9A/g	9: 7g 9=: g 9@-g 9A/g	9: 7g 9=: g 9@-g 9A/g
as s w Qw s ΔΔ	887g 88/Ag 8: g 8 Bg	887g 88/Ag 8: g 8 Bg	887g 88/Ag 8: g 8 Bg	887g 88/Ag 8: g 8 Bg	887g 88/Ag 8: g 8 Bg	887g 88/Ag 8: g 8 Bg	887g 88/Ag 8: g 8 Bg	887g 88/Ag 8: g 8 Bg	887g 88/Ag 8: g 8 Bg	887g 88/Ag 8: g 8 Bg	887g 88/Ag 8: g 8 Bg	887g 88/Ag 8: g 8 Bg	887g 88/Ag 8: g 8 Bg	887g 88/Ag 8: g 8 Bg	887g 88/Ag 8: g 8 Bg	887g 88/Ag 8: g 8 Bg	887g 88/Ag 8: g 8 Bg	887g 88/Ag 8: g 8 Bg	887g 88/Ag 8: g 8 Bg
W S k	225 236 236 <b>236</b>	220 230 230 <b>230</b>	210 220 220 <b>220</b>	195 205 205 <b>205</b>	168 176 176 <b>176</b>	176													
W V k	180 189 189 <b>189</b>	176 184 184 <b>184</b>	168 176 176 <b>176</b>	156 164 164 <b>164</b>	134 141 141 <b>141</b>	141													
W S k	253 264 264 <b>264</b>	242 253 253 <b>253</b>	230 240 240 <b>240</b>	210 220 220 <b>220</b>	184 192 192 <b>192</b>	192													
W V k	202 211 211 <b>211</b>	194 202 202 <b>202</b>	184 192 192 <b>192</b>	168 176 176 <b>176</b>	147 154 154 <b>154</b>	154													
W S k	289 300 300 <b>300</b>	274 284 284 <b>284</b>	260 270 270 <b>270</b>	240 250 250 <b>250</b>	208 216 216 <b>216</b>	216													
W V k	231 240 240 <b>240</b>	219 227 227 <b>227</b>	208 216 216 <b>216</b>	192 200 200 <b>200</b>	166 173 173 <b>173</b>	173													
W S k	319 330 330 <b>330</b>	305 316 316 <b>316</b>	290 300 300 <b>300</b>	270 280 280 <b>280</b>	232 240 240 <b>240</b>	240													
W V k	255 264 264 <b>264</b>	244 253 253 <b>253</b>	232 240 240 <b>240</b>	216 224 224 <b>224</b>	186 192 192 <b>192</b>	192													
W S k	358 374 396 <b>396</b>	341 357 378 <b>378</b>	325 340 360 <b>360</b>	300 310 330 <b>330</b>	260 272 288 <b>288</b>	288													
W V k	286 299 317 <b>317</b>	273 286 302 <b>302</b>	260 272 288 <b>288</b>	240 248 264 <b>264</b>	208 218 230 <b>230</b>	230													
W S k	402 444 444 <b>444</b>	391 438 438 <b>438</b>	380 420 420 <b>420</b>	350 385 385 <b>385</b>	304 336 336 <b>336</b>	336													
W V k	322 355 355 <b>355</b>	313 350 350 <b>350</b>	304 336 336 <b>336</b>	280 308 308 <b>308</b>	243 269 269 <b>269</b>	269													
W S k	413 455 455 <b>455</b>	401 442 442 <b>453</b>	390 430 430 <b>440</b>	359 394 394 <b>403</b>	312 344 344 <b>352</b>	352													
W V k	330 364 364 <b>372</b>	321 354 354 <b>362</b>	312 344 344 <b>352</b>	287 315 315 <b>322</b>	250 275 275 <b>282</b>	282													



## 4 Dn t GQHH

f s s vw / wSR] @7.; 4 0	RP^: B 8d; P	RP^: B 9d; P	RP^: B 8; P	RP^: B 9[; P	RP^: B 8Z; P	RP^: B 9Z; P	RP^: B gZ; P
<b>Xd</b> Q° wu 4s ° uz w6u s uw %	203,9	207	198,7	214,2	215,3	222,5	226,3
<b>X'd</b> Q° wu 4s ° s 'w w6u s uw %	10	11,4	12,7	14,5	15,8	17,8	19,2
<b>X''d</b> Q° wu 4s ° t s 'w w6u s uw %	5,69	6,11	6,72	7,45	8,38	9,73	10,8
<b>Xq</b> b sv s w4s ° uz w6u s uw %	100,3	113,8	109,7	121,1	124,2	130,4	135,6
<b>X'q</b> b sv s w4s ° s 'w w6u s uw %	100,3	113,8	109,7	121,1	124,2	130,4	135,6
<b>X''q</b> b sv s w4s ° t s 'w w6u s uw %	20,4	22,2	23	22,8	21,5	20,8	20,1
<b>X2</b> ] wys ° v4 w w uw w6u s uw %	13,2	14,8	15,9	16,6	16,7	16,2	15,6
<b>X0</b> l w w w uw w6u s uw %	2,79	2,59	2,69	2,48	2,38	2,28	2,18
ds s vw							
<b>Xd</b> Q° wu 4s ° uz w6u s uw %	169,2	171,8	164,9	177,8	178,7	184,7	187,8
<b>X'd</b> Q° wu 4s ° s 'w w6u s uw %	8,33	9,45	10,5	12	13,1	14,8	15,9
<b>X''d</b> Q° wu 4s ° t s 'w w6u s uw %	4,72	5,07	5,58	6,19	6,96	8,08	8,96
<b>Xq</b> b sv s w4s ° uz w6u s uw %	83,2	94,5	91	100,5	103,1	108,2	112,5
<b>X'q</b> b sv s w4s ° s 'w w6u s uw %	83,2	94,5	91	100,5	103,1	108,2	112,5
<b>X''q</b> b sv s w4s ° t s 'w w6u s uw %	16,9	18,5	19,1	18,9	17,9	17,3	16,7
<b>X2</b> ] wys ° v4 w w uw w6u s uw %	11	12,3	13,2	13,7	13,8	13,5	12,9
<b>X0</b> l w w w uw w6u s uw %	2,79	2,59	2,69	2,48	2,38	2,28	2,18
<b>Kcc</b> dz u° u ° s °	0,44	0,46	0,45	0,44	0,43	0,42	0,53
<b>T'd</b> e s 'w ° wu s sec	0,073	0,078	0,083	0,085	0,091	0,099	0,102
<b>T''d</b> d t s 'w ° wu s sec	0,011	0,012	0,013	0,013	0,012	0,013	0,012
<b>T'do</b> ^ w u° u ° wu s sec	0,7	0,9	1,1	1,3	1,4	1,5	1,6
<b>Ta</b> N s w ° wu s sec	0,015	0,016	0,018	0,017	0,016	0,013	0,015

## l Dn t GQHH

<b>lo</b> R u° s ° u w s sv A	0,8	0,7	0,67	0,71	0,78	0,72	0,6
<b>lc</b> R u° s ° u w s x sv A	3,2	3,0	3,0	2,8	3,9	3,9	3,1
^ w sv 4							
^ w sv w 97 w4s 300							
<b>Uw6</b> v° s ° W	11844	12600	13548	14133	16137	19465	20239
<b>eww z</b> wUs 'uSsu 4eUS %	<2	<2	<2	<2	<2	<2	<2
<b>h s wk</b> Q° 5eUQ0x sv ZZ6Z] %	3,1 / 3	3 / 2,9	2,8 / 2,9	2,9 / 3,1	3 / 2,9	3,1 / 2,9	3,2 / 3
<b>h s wk</b> Q° 5eUQ0 sv ZZ6Z] %	2,8 / 2,7	2,7 / 2,6	2,6 / 2,8	2 / 2,1	2,6 / 2,8	2,7 / 2,7	2,8 / 2,6



## 4 Dn t GQVH

f s s vw / wSR] @7.; 4 0	RP^: B 8d; P	RP^: B 9d; P	RP^: B 8; P	RP^: B 9[; P	RP^: B 8Z; P	RP^: B 9Z; P	RP^: B gZ; P
<b>Xd</b> Q° wu 4s ° uz w6u s uw %	207,7	207	198,7	214,2	215,3	222,5	224,3
<b>X'd</b> Q° wu 4s ° s 'w w6u s uw %	10,2	11,4	12,7	14,5	15,8	17,8	19
<b>X''d</b> Q° wu 4s ° t s 'w w6u s uw %	5,8	6,11	6,72	7,45	8,38	9,73	10,7
<b>Xq</b> b sv s w4s ° uz w6u s uw %	102,1	113,8	109,7	121,1	124,2	130,4	134,4
<b>X'q</b> b sv s w4s ° s 'w w6u s uw %	102,1	113,8	109,7	121,1	124,2	130,4	134,4
<b>X''q</b> b sv s w4s ° t s 'w w6u s uw %	20,8	22,2	23	22,8	21,5	20,8	19,9
<b>X2</b> ] w4s ° w4 w uw w6u s uw %	13,5	14,8	15,9	16,6	16,7	16,2	15,5
<b>X0</b> l w w uw w6u s uw %	2,85	2,59	2,69	2,48	2,38	2,28	2,16
ds s vw							
<b>Xd</b> Q° wu 4s ° uz w6u s uw %	172,4	171,8	164,9	177,8	178,7	184,7	186,2
<b>X'd</b> Q° wu 4s ° s 'w w6u s uw %	8,49	9,45	10,5	12	13,1	14,8	15,8
<b>X''d</b> Q° wu 4s ° t s 'w w6u s uw %	4,81	5,07	5,58	6,19	6,96	8,08	8,88
<b>Xq</b> b sv s w4s ° uz w6u s uw %	84,8	94,5	91	100,5	103,1	108,2	111,6
<b>X'q</b> b sv s w4s ° s 'w w6u s uw %	84,8	94,5	91	100,5	103,1	108,2	111,6
<b>X''q</b> b sv s w4s ° t s 'w w6u s uw %	17,2	18,5	19,1	18,9	17,9	17,3	16,5
<b>X2</b> ] w4s ° w4 w uw w6u s uw %	11,2	12,3	13,2	13,7	13,8	13,5	12,9
<b>X0</b> l w w uw w6u s uw %	2,85	2,59	2,69	2,48	2,38	2,28	2,16
<b>Kcc</b> dz u° u ° s °	0,44	0,46	0,45	0,44	0,43	0,42	0,54
<b>T'd</b> e s 'w ° wu s sec	0,073	0,078	0,083	0,085	0,091	0,099	0,102
<b>T''d</b> d t s 'w ° wu s sec	0,011	0,012	0,013	0,013	0,012	0,013	0,012
<b>T'do</b> ^ w u° u ° wu s sec	0,7	0,9	1,1	1,3	1,4	1,5	1,6
<b>Ta</b> N s w ° wu s sec	0,015	0,016	0,018	0,017	0,016	0,013	0,015

## l Dn t GQVH

<b>lo</b> R u° s ° u w s sv A	0,8	0,65	0,65	0,7	0,7	0,7	0,6
<b>lc</b> R u° s ° u w s x sv A	3,2	2,9	2,9	2,8	3,8	3,9	3,1
^ w sv 4							
^ w sv w 97 w4s 300							
<b>Uw6</b> v° s ° W	12437	12691	13299	13968	16118	20310	20881
<b>ewwz</b> wV w4w s uwSsu 4e15	<40	<40	<40	<40	<40	<40	<40
<b>h s wk</b> Q° 5eUQ0x sv ZZ6Z] %	3,1 / 3	3 / 2,9	2,8 / 2,9	2,9 / 3,1	3 / 2,9	3,1 / 2,9	3,2 / 3
<b>h s wk</b> Q° 5eUQ0 sv ZZ6Z] %	2,8 / 2,7	2,7 / 2,6	2,6 / 2,8	2 / 2,1	2,6 / 2,8	2,7 / 2,7	2,8 / 2,6



p i RHt

[ vw			: 87g =7U					: 77g =7U					: 8-g =7U					: ; 7g =7U				
			79=	75=	75=	8	88	79=	75=	75=	8	88	79=	75=	75=	8	88	79=	75=	75=	8	88
RP^: B 8d; P	%		89,1	91,2	92,3	92,3	92,1	88,9	91,3	92,6	92,4	92,1	88,7	91,3	92,5	92,1	91,8	88,5	91,1	92,2	91,9	91,5
RP^: B 9d; P	%		90,1	91,6	92,6	92,6	92,4	89,9	91,7	92,9	92,7	92,4	89,7	91,7	92,8	92,4	92,1	89,5	91,5	92,5	92,2	91,8
RP^: B 8; P	%		89,6	91,9	93,0	92,9	92,7	89,4	92,0	93,3	93,0	92,7	89,2	92,0	93,2	92,7	92,4	89,0	91,8	92,9	92,5	92,1
RP^: B 9[ ; P	%		90,1	92,3	93,4	93,3	93,1	89,9	92,4	93,7	93,4	93,1	89,7	92,4	93,6	93,1	92,8	89,5	92,2	93,3	92,9	92,5
RP^: B 8Z; P	%		90,2	92,7	93,8	93,5	93,3	89,9	92,7	94,0	93,7	93,4	89,7	92,7	93,9	93,4	93,1	89,5	92,5	93,6	93,2	92,8
RP^: B 9Z; P	%		90,1	92,5	93,4	93,4	93,2	89,9	92,6	93,7	93,5	93,2	89,7	92,6	93,6	93,2	92,9	89,5	92,4	93,3	93,0	92,6
RP^: B 9Z; P	%		90,3	92,4	93,5	93,5	93,3	90,1	92,5	93,8	93,6	93,3	89,9	92,5	93,7	93,3	93,0	89,7	92,3	93,4	93,1	92,8

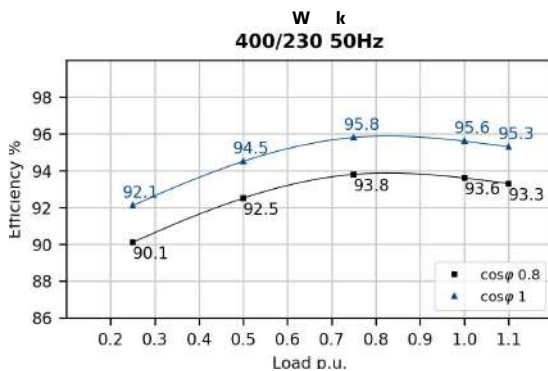
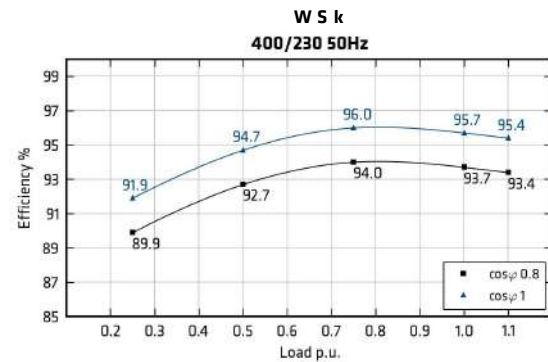
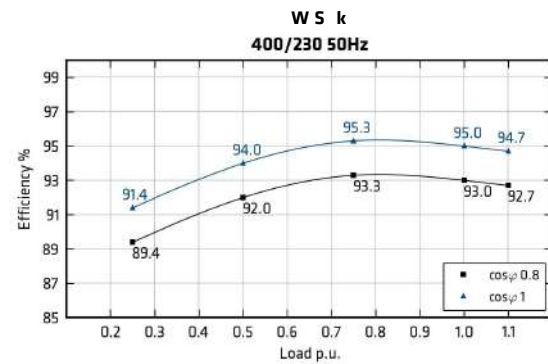
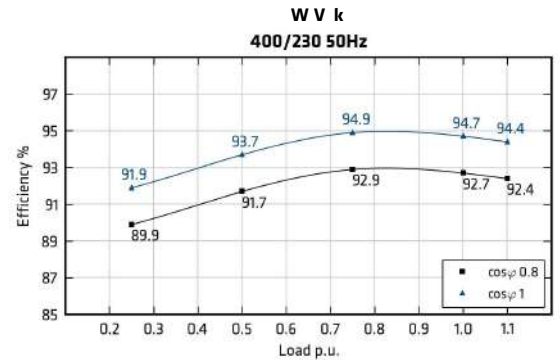
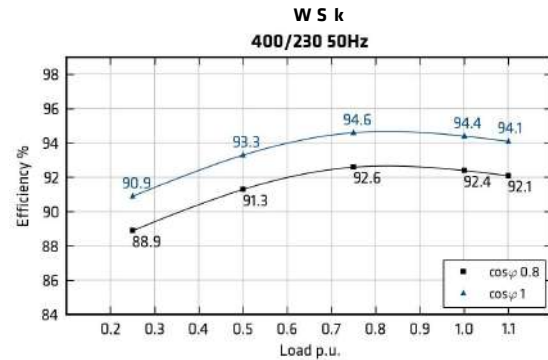



p i SHt

[ vw		; 8-g @U					; 7-g @U					; 6-g @U					; 5-g @U				
		75=	75=	75=	8	88	75=	75=	75=	8	88	75=	75=	75=	8	88	75=	75=	75=	8	88
RP <sup>+</sup> : B 8d; P	%	90,1	92,0	93,0	92,7	92,4	90,1	92,1	93,2	93,2	93,0	90,1	92,2	93,4	93,3	93,2	89,9	92,3	93,6	93,4	93,2
RP <sup>+</sup> : B 9d; P	%	90,6	92,5	93,4	93,1	92,8	90,6	92,6	93,6	93,6	93,4	90,6	92,7	93,8	93,7	93,6	90,4	92,8	94,0	93,8	93,6
RP <sup>+</sup> : B 8f; P	%	90,6	93,1	93,9	93,5	93,2	90,6	93,2	94,1	94,0	93,8	90,6	93,3	94,3	94,1	94,0	90,4	93,4	94,5	94,2	94,0
RP <sup>+</sup> : B 9f; P	%	90,6	93,4	94,3	93,8	93,5	90,6	93,5	94,5	94,3	94,1	90,6	93,6	94,7	94,4	94,2	90,4	93,7	94,9	94,5	94,1
RP <sup>+</sup> : B 8Z; P	%	90,6	93,6	94,5	94,0	93,7	90,6	93,7	94,7	94,5	94,3	90,6	93,8	94,9	94,6	94,4	90,4	93,9	95,1	94,7	94,3
RP <sup>+</sup> : B 9Z; P	%	90,6	93,0	93,9	93,6	93,3	90,6	93,1	94,1	94,1	93,9	90,6	93,2	94,3	94,2	94,0	90,4	93,3	94,5	94,3	93,9
RP <sup>+</sup> : B 8Z; P	%	90,8	92,9	94,0	93,7	93,4	90,8	93,0	94,2	94,2	94,0	90,8	93,1	94,4	94,3	94,1	90,6	93,2	94,6	94,4	94,2

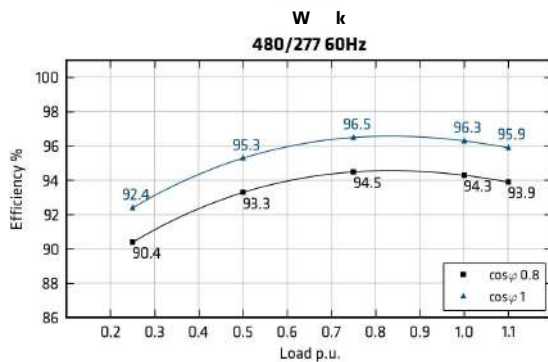
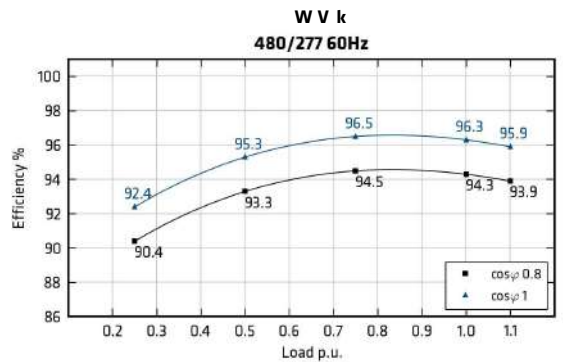
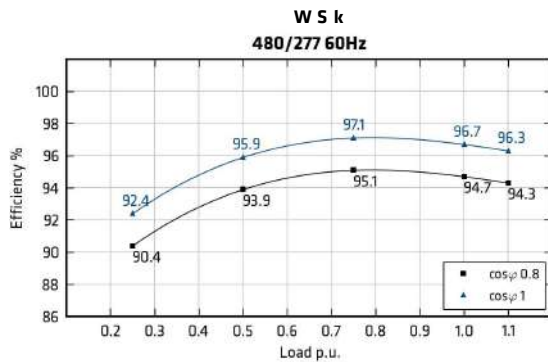
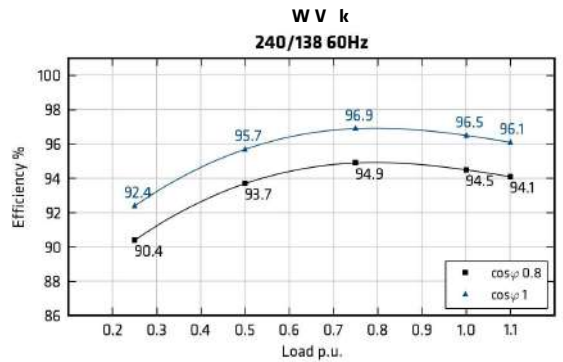
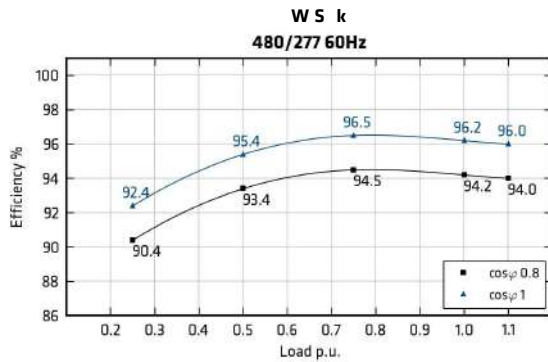
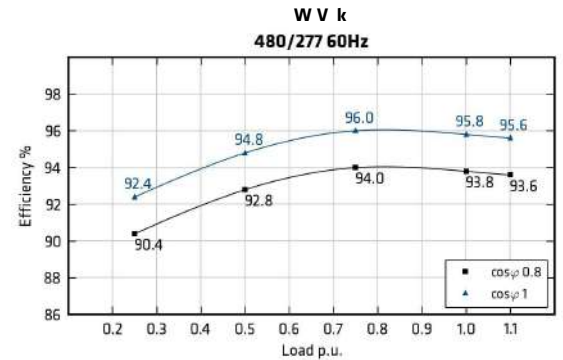
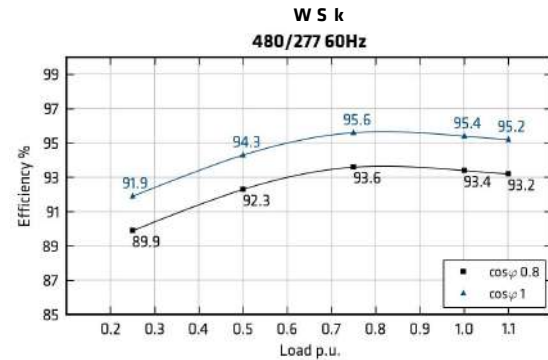



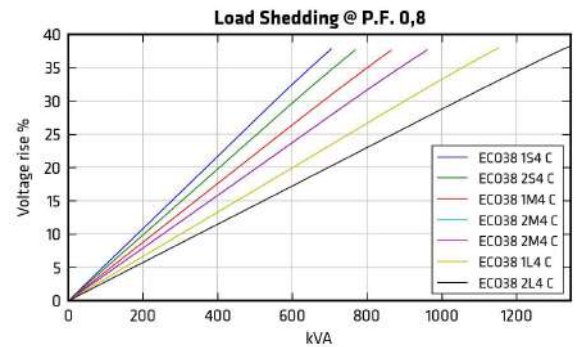
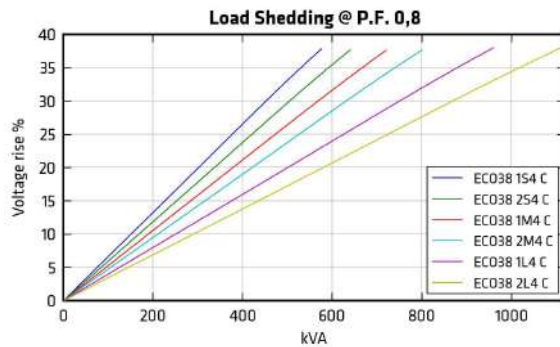
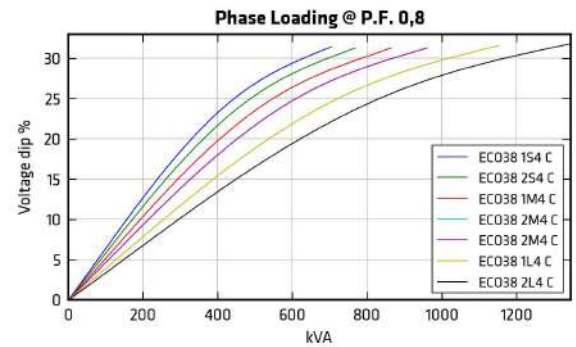
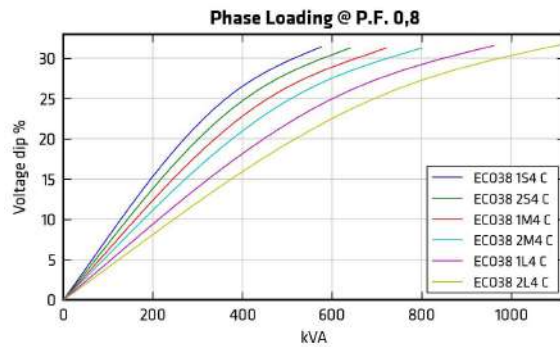
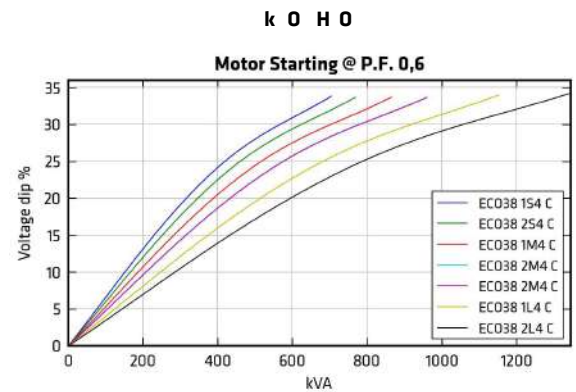
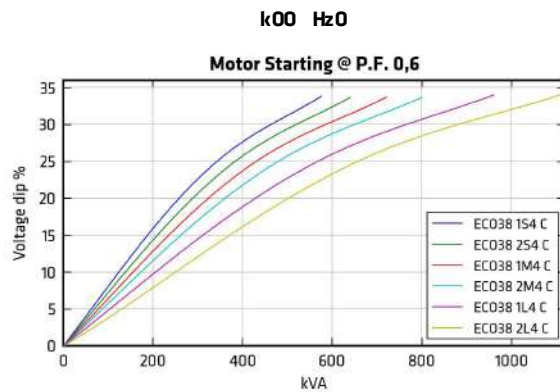

V vw usws w u w s s x u° xs w xsu syw°x ° v'us w3 w6 w uww s x D

a w Ssu u w w u w u /aSPPH° tw w w xsu 75@u w D

aSPPH° /Nc Pu /aS w 0679B

R s w6ezwaSPPs w xsu 75° 88C9 maSPPH° /Nc Pu /75 0679B 06ez° w6 zs zw sywxs s sy° w w s x75° w ° s w zw wzs us tw w6v zw x75@u w°x zw sv° u vww 88C9° w t'yyw /8C, z'yzw s w605

V z° ws w8s 877 gN sv° w° s x75° w ° s w° sywxs s 88C gN sv° w° s x75@5

g sywu w w u w /gPPD

gPPH/;776g w 0°x=7 U EgPPH/; B76g w 0°x@ U

R s w6gPPs ;8-g @ U ° 88:B mgPPH/; B76; 8-q906ez° w6 zs zw sywxs s sy° w w s ;8-g° w ° s w zw wzs us tw w6v zw w xsu 75@u w°x zw sv° u vww 88:B° w t'yyw /:; z'yzw s w605

V z° ws w8s 877 gN sv° w° s ;8-g° w ° s w° sywxs s 88: gN sv° w° s ;B7g5



RHt

D

RP^: B 8d; P

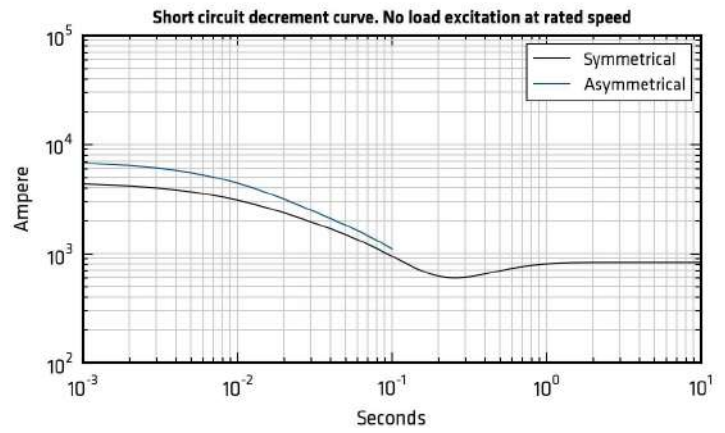

RP^: B 9d; P

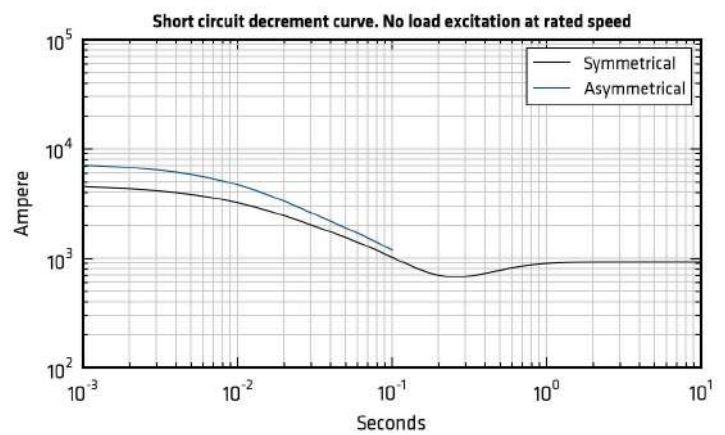

RP^: B 9[ ; P

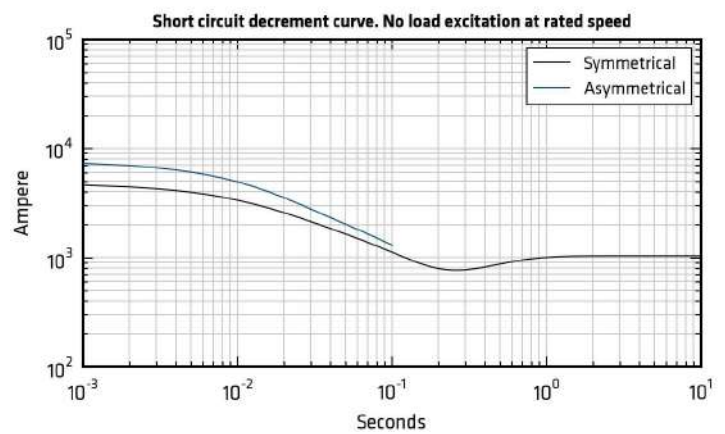

RP^: B 9[ ; P

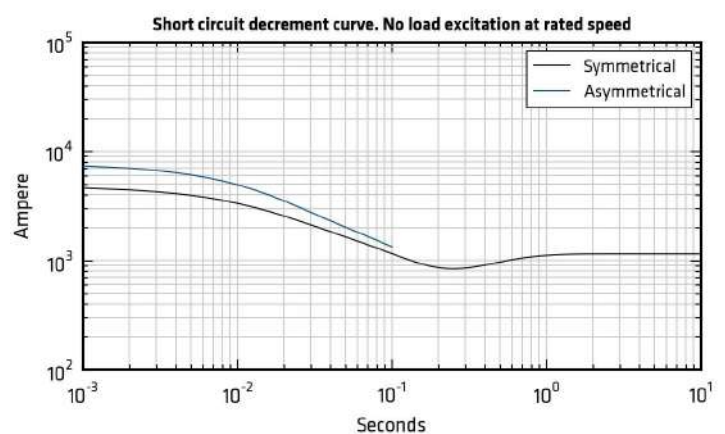



RHt

D

RP^ : B 8Z; P

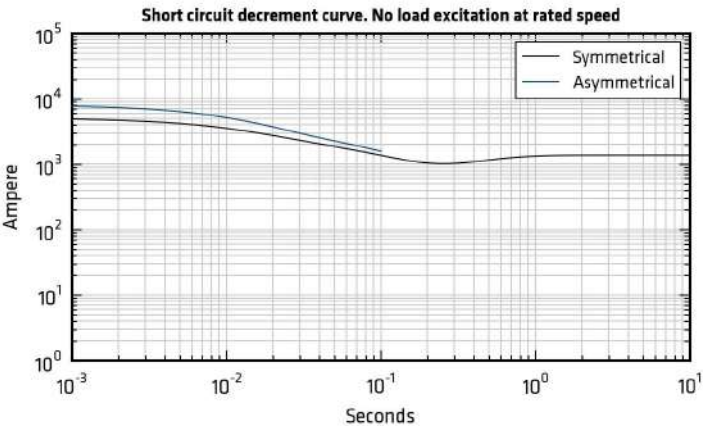

RP^ : B 9Z; P

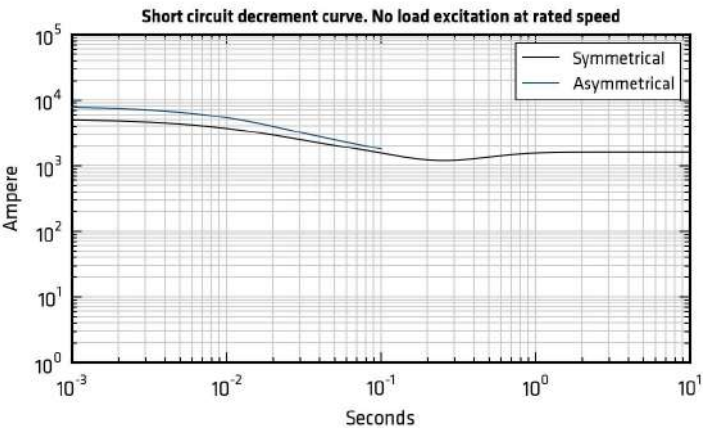

RP^ : B gZ; P

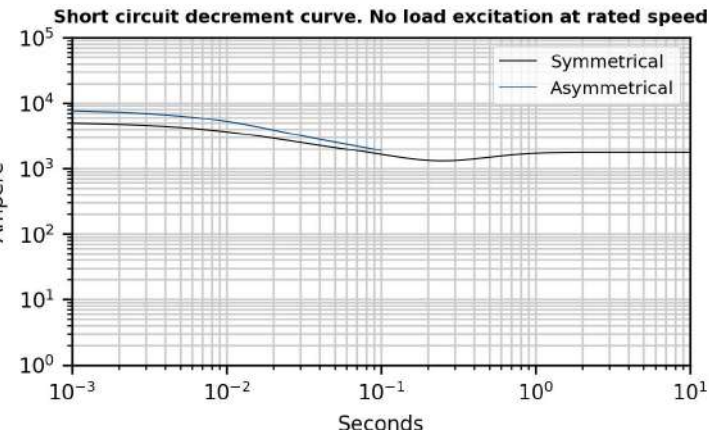



Sht

D

RP^ : B 8d; P

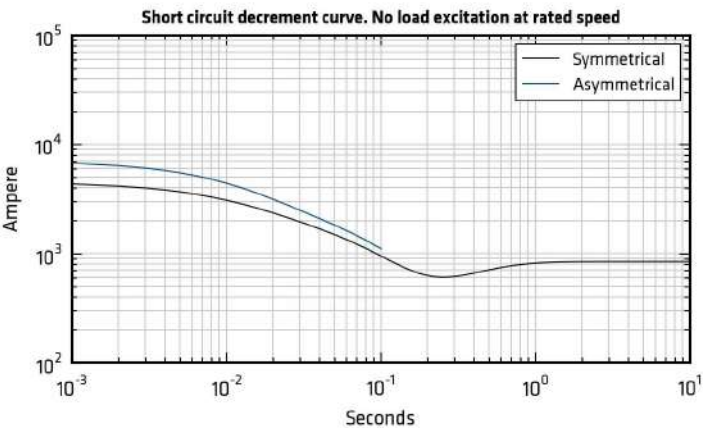

RP^ : B 9d; P

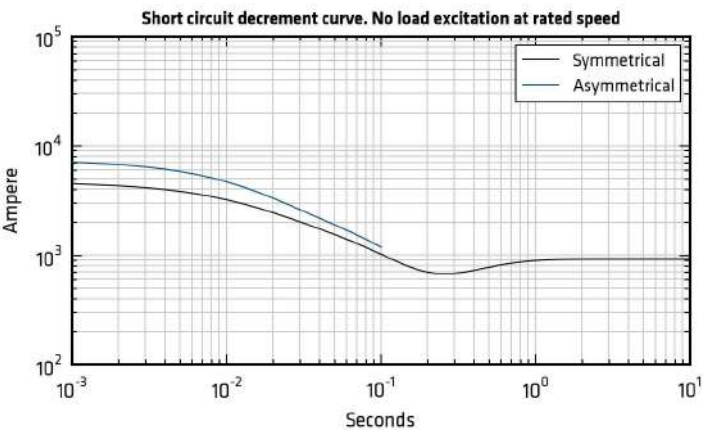

RP^ : B 9[ ; P

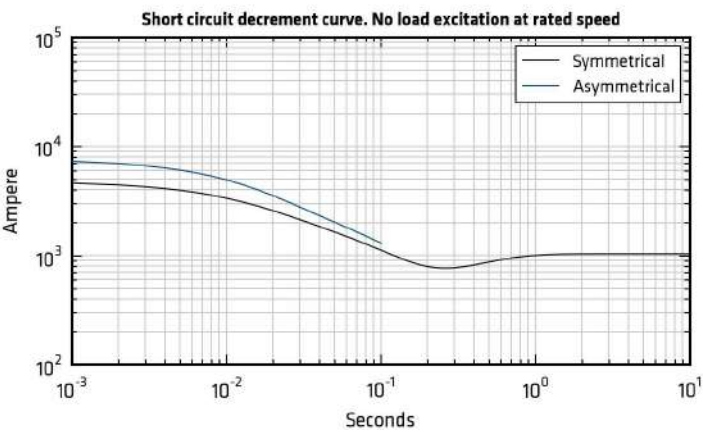

RP^ : B 9[ ; P

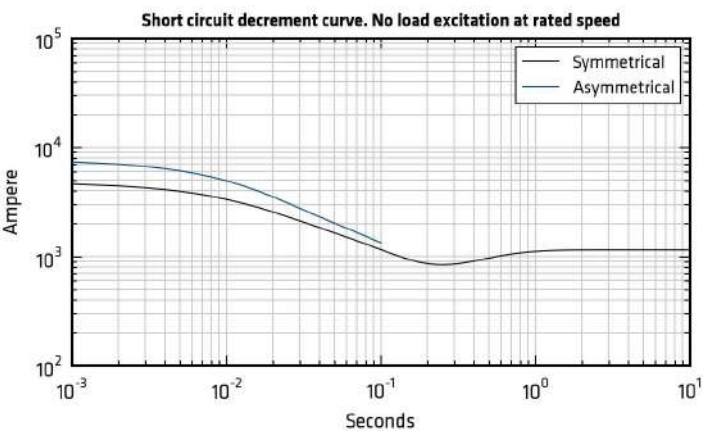



Sht

D

RP^ : B 8Z; P

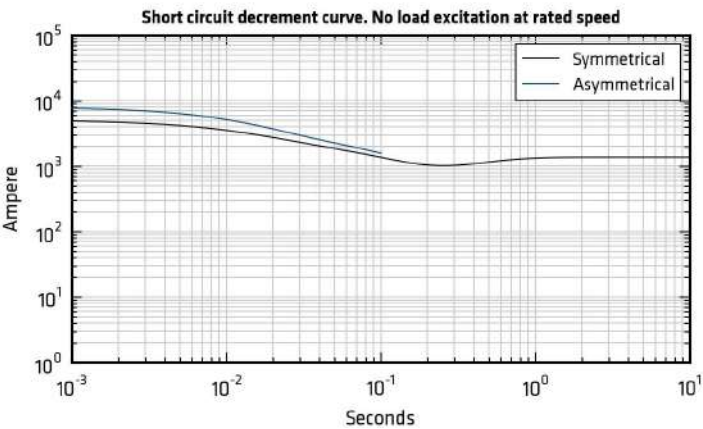

RP^ : B 9Z; P

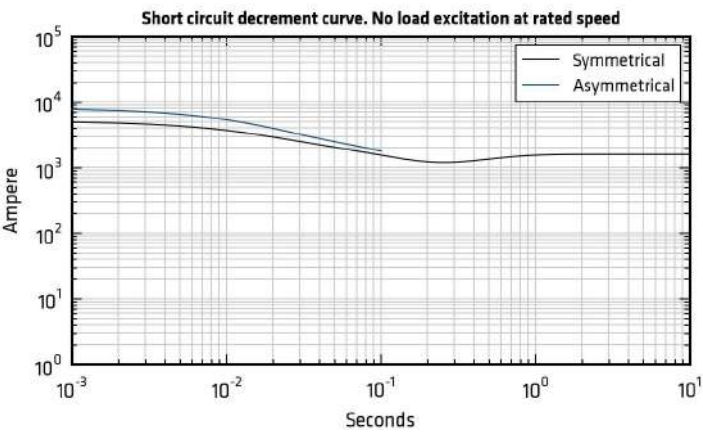

RP^ : B gZ; P

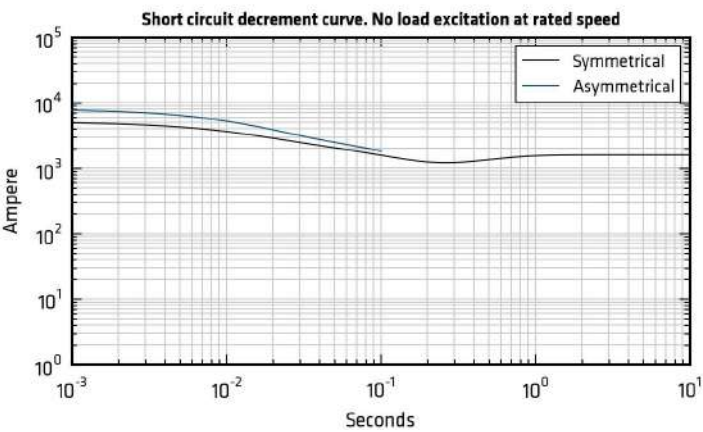



l n

Qs s		RP^: B 8d; P		RP^: B 9d; P		RP^: B 8[ ; P		RP^: B 9[ ; P		RP^: B 8Z; P		RP^: B 9Z; P		RP^: B 8Z; P	
		=7U	@U	=7U	@U	=7U	@U	=7U	@U	=7U	@U	=7U	@U	=7U	@U
Qs w usyw		P w													
d s h ° v° y c w ° s uw/97 P0	Ω	0,013		0,011		0,008		0,007		0,006		0,004		0,004	
c h ° v° y c w ° s uw/97 P0	Ω	3,905		4,133		4,449		4,887		5,604		6,78		7,383	
d s R u' w c w ° s uw/97 P0	Ω	13,47		13,47		13,47		15,28		13,47		13,47		13,47	
c R u' w c w ° s uw/97 P0	Ω	0,719		0,719		0,719		0,719		0,719		0,719		0,719	
h wlyz x u w w y w w s	kg	525,0		550,0		600,0		653,0		771,0		895,0		957,0	
f t s s u w s y w'u	kN/mm	4,4		5,2		5,7		5,1		5,9		6,2		6,5	
N° x	m³/min	32,0	39,0	32,0	39,0	32,0	39,0	32,0	39,0	32,0	39,0	32,0	39,0	32,0	39,0
] ° w w w s 8 6A	dB(A)	82/69	86/73	82/69	86/73	82/69	86/73	82/69	86/73	82/69	86/73	82/69	86/73	82/69	86/73

0

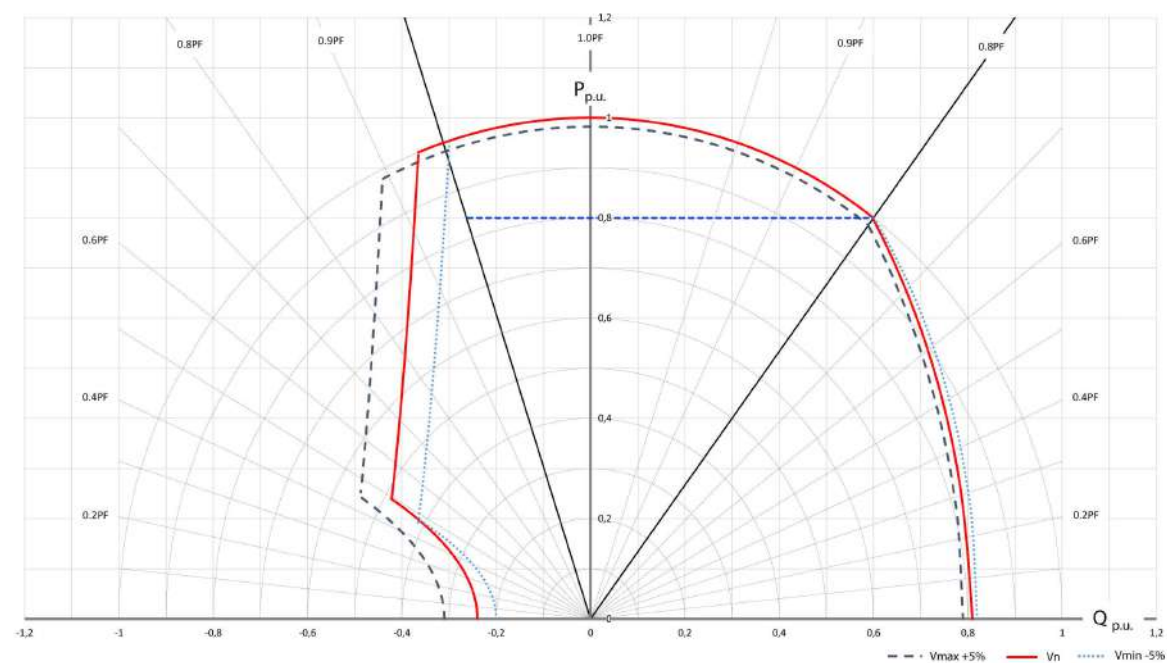



## MOMENTS OF INERTIA - DOUBLE BEARING

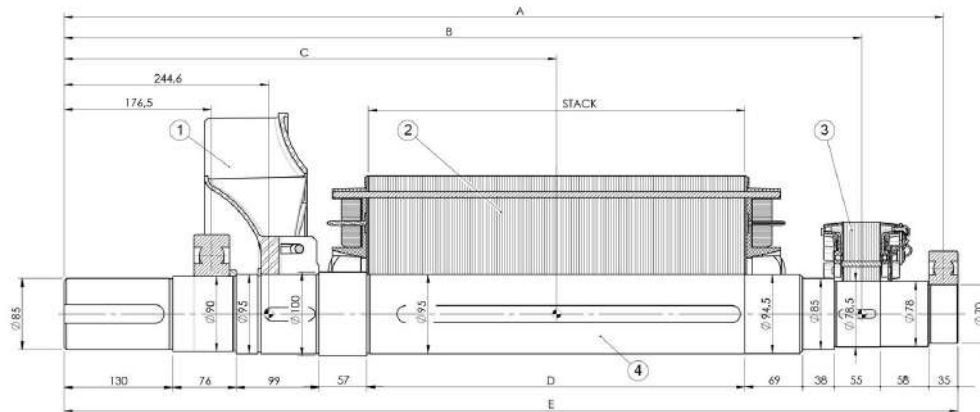

POS.	1		2		3		4		TOTAL	
COMPONENT	FAN		MAIN ROTOR		EXCITER ROTOR		SHAFT *			
TYPE	WEIGHT	J	WEIGHT	J	WEIGHT	J	WEIGHT	J	WEIGHT	J
	[kg]	[kgm <sup>2</sup> ]	[kg]	[kgm <sup>2</sup> ]	[kg]	[kgm <sup>2</sup> ]	[kg]	[kgm <sup>2</sup> ]	[kg]	[kgm <sup>2</sup> ]
ECO38 1S / 4C	6,6	0,1633	106,2	1,4461	11,7	0,0806	40,8	0,0426	165,3	1,7326
ECO38 2S / 4C			115,9	1,5767					175,0	1,8632
ECO38 1M / 4C			130,4	1,7724			44,7	0,0471	193,4	2,0634
ECO38 2M / 4C			150,0	2,0378					213,0	2,3287
ECO38 1L / 4C			184,2	2,5007			54,2	0,058	256,8	2,8026
ECO38 2L / 4C			232,9	3,1584					305,4	3,4602
ECO38 VL / 4C			253,0	3,4336			56,5	0,0605	327,8	3,7380

DIMENSION	A	B	C	D	E
TYPE	[mm]	[mm]	[mm]	[mm]	[mm]
ECO38 1S / 4C	811,5	714,2	479,0	212,0	829,0
ECO38 2S / 4C			469,0		
ECO38 1M / 4C	881,5	784,2	524,0	282,0	899,0
ECO38 2M / 4C			504,0		
ECO38 1L / 4C	1051,5	954,2	639,0	452,0	1069,0
ECO38 2L / 4C			589,0		
ECO38 VL / 4C	1091,5	994,2	609,0	492,0	1109,0

\* Shaft mass and inertia also include rotor keys

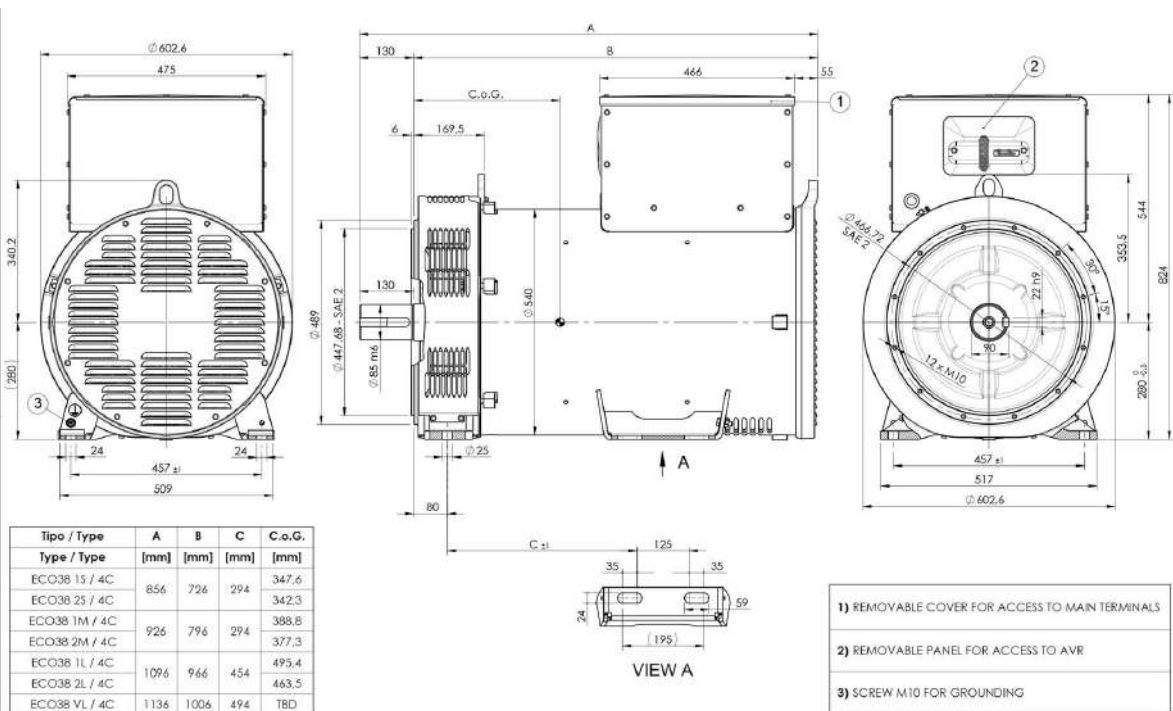



# MOMENTS OF INERTIA - SINGLE BEARING

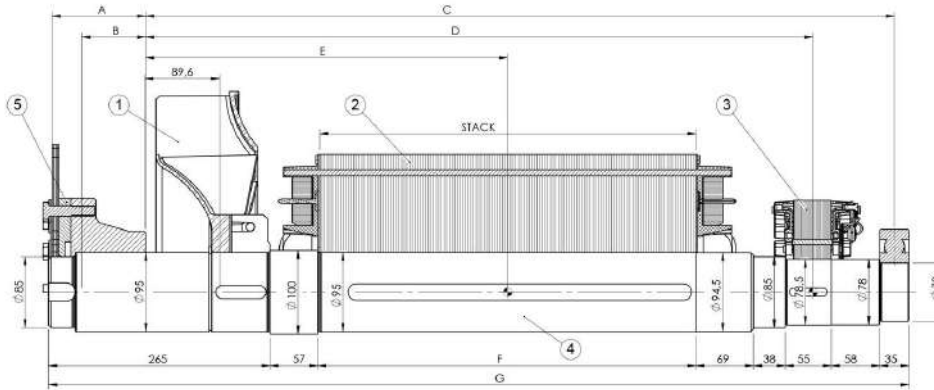

\* Shaft mass and inertia also include rotor keys

POS.	1	2	3	4	TOTAL	
COMPONENT	FAN	MAIN ROTOR	EXCITER ROTOR	SHAFT *	WEIGHT	J
TYPE	WEIGHT [kg]	J [kgm <sup>2</sup> ]	WEIGHT [kg]	J [kgm <sup>2</sup> ]	WEIGHT [kg]	J [kgm <sup>2</sup> ]
ECO38 1S / 4C	6,6	0,1633	11,7	0,0806	40,2	0,0434
ECO38 2S / 4C					164,8	1,7333
ECO38 1M / 4C					174,5	1,8639
ECO38 2M / 4C					192,9	2,0641
ECO38 1L / 4C					212,5	2,3295
ECO38 2L / 4C					256,2	2,8033
ECO38 VL / 4C					304,9	3,4610
ECO38 VL / 4C					55,9	0,0613
ECO38 VL / 4C					327,2	3,7388

SAE N.	A	B	WEIGHT [kg]	J [kgm <sup>2</sup> ]
11,5	110,6	75,7	19,3	0,1793
14,0	96,4	74,1	22,4	0,3630

DIMENSION	C	D	E	F	G
TYPE	[mm]	[mm]	[mm]	[mm]	[mm]
ECO38 1S / 4C	656,5	559,2	324,0	212,0	789,0
ECO38 2S / 4C					
ECO38 1M / 4C	726,5	629,2	369,0	282,0	859,0
ECO38 2M / 4C					
ECO38 1L / 4C	896,5	799,2	484,0	452,0	1029,0
ECO38 2L / 4C					
ECO38 VL / 4C	936,5	839,2	454,0	492,0	1069,0

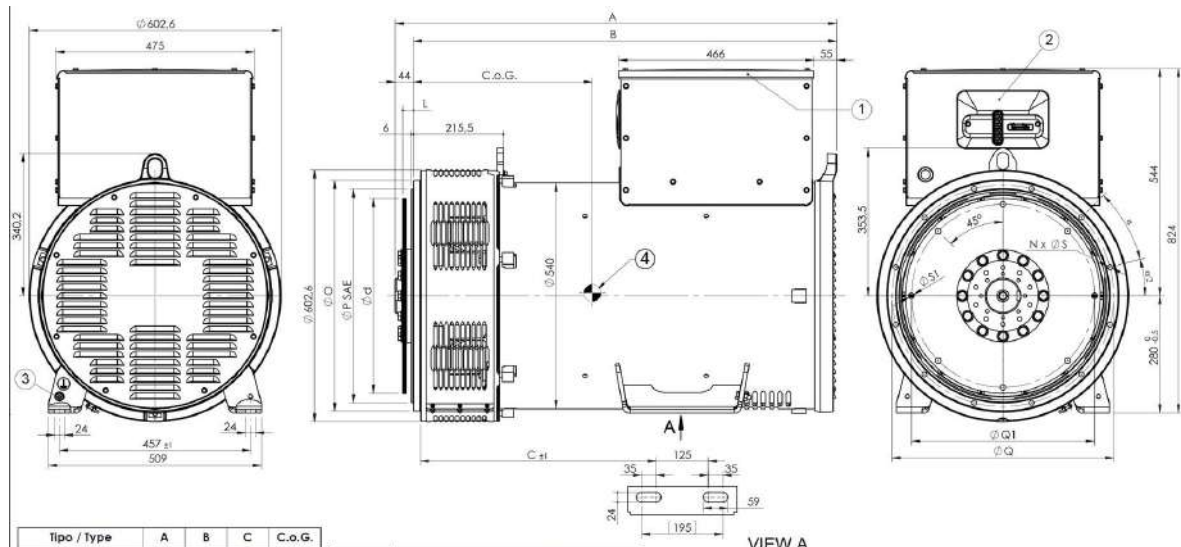

Tipo / Type	A	B	C	C.o.G.
Type / Type	[mm]	[mm]	[mm]	[mm]
ECO38 1S / 4C	816	772	420	388,7
ECO38 2S / 4C				383,6
ECO38 1M / 4C	886	842	420	430,5
ECO38 2M / 4C				419,4
ECO38 1L / 4C	1056	1012	580	538,1
ECO38 2L / 4C				506,7
ECO38 VL / 4C	1096	1052	620	527,0

SAE N.	O	P	Q	S	N	a
3	451	409,58	428,62	12	12	30
2	489	447,68	466,72	12	12	30
1	552	511,18	530,22	12	12	30
1/2	648	584,20	619,12	14	12	30
0	711	647,70	679,45	14	16	22,5

SAE N.	d	L	Q1	S1
11 1/2	352,42	39,6	333,37	11
14	466,72	25,4	438,15	13,5

- 1) REMOVABLE COVER FOR ACCESS TO MAIN TERMINALS
- 2) REMOVABLE PANEL FOR ACCESS TO AVR
- 3) SCREW M10 FOR GROUNDING
- 4) CENTER OF GRAVITY IN CONFIGURATION SAE 1 FLYWHEEL 14



Handwriting practice lines consisting of 20 horizontal lines.







---

**Mecc Alte SpA (HQ)**

Via Roma  
20 - 36051 Creazzo  
Vicenza - ITALY  
T: +39 0444 396111  
F: +39 0444 396166  
E: info@meccalte.it  
aftersales@meccalte.it

---

**Mecc Alte Portable**

Via Roma  
20 - 36051 Creazzo  
Vicenza - ITALY  
T: +39 0444 396111  
F: +39 0444 396166  
E: info@meccalte.it  
aftersales@meccalte.it

---

**Mecc Alte Power Products srl**

Via Melaro  
Z - 36075 Montecchio  
Maggiore (VI) - ITALY  
T: +39 0444 1831295  
F: +39 0444 1831306  
E: info@meccalte.it  
aftersales@meccalte.it

---

**Zanardi Alternatori srl**

Via Dei Laghi  
48/B - 36077 Altavilla  
Vicenza - ITALY  
T: +39 0444 370799  
F: +39 0444 370330  
E: info@zanardialternatori.it

---

**United Kingdom**

Mecc Alte U.K. LTD  
6 Lands' End Way  
Oakham  
Rutland LE15 6RF  
T: +44 (0) 1572 771160  
F: +44 (0) 1572 771161  
E: info@meccalte.co.uk  
aftersales@meccalte.co.uk

---

**Spain**

Mecc Alte España S.A.  
C/ Rio Taibilla, 2  
Polig. Ind. Los Valeros  
03178 Benijofar (Alicante)  
T: +34 (0) 96 6702152  
F: +34 (0) 96 6700103  
E: info@meccalte.es  
aftersales@meccalte.es

---

**China**

Mecc Alte Alternator Haimen LTD  
755 Nanhai East Rd  
Jiangsu HEDZ 226100 PRC  
T: +86 (0) 513 82325758  
F: +86 (0) 513 82325768  
E: info@meccalte.cn  
aftersales@meccalte.cn

---

**India**

Mecc Alte India PVT LTD  
Plot NO: 1, Sanaswadi  
Talegaon  
Dhamdhare Road Taluka:  
Shirur, District:  
Pune - 412208  
Maharashtra, India  
T: +91 2137 619600  
F: +91 2137 619699  
E: info@meccalte.in  
aftersales@meccalte.in

---

**U.S.A. and Canada**

Mecc Alte Inc.  
1229 Adams Drive  
McHenry, IL, 60051  
T: +1 815 344 0530  
F: +1 815 344 0535  
E: info@meccalte.us  
aftersales@meccalte.us

---

**Germany**

Mecc Alte Generatoren GmbH  
Ensener Weg 21  
D-51149 Köln  
T: +49 (0) 2203 503810  
F: +49 (0) 2203 503796  
E: info@meccalte.de  
aftersales@meccalte.de

---

**Australia**

Mecc Alte Alternators PTY LTD  
10 Duncan Road, PO Box 1046  
Dry Creek, 5094, South  
Australia  
T: +61 (0) 8 8349 8422  
F: +61 (0) 8 8349 8455  
E: info@meccalte.com.au  
aftersales@meccalte.com.au

---

**France**

Mecc Alte International S.A.  
Z.E. La Gagnerie  
16330 ST. Amant de Boixe  
T: +33 (0) 545 397562  
F: +33 (0) 545 398820  
E: info@meccalte.fr  
aftersales@meccalte.fr

---

**Far East**

Mecc Alte (F.E.) PTE LTD  
19 Kian Teck Drive  
Singapore 628836  
T: +65 62 657122  
F: +65 62 653991  
E: info@meccalte.com.sg  
aftersales@meccalte.com.sg



[www.meccalte.com](http://www.meccalte.com)